

CLIC Detectors and Physics

Jan Strube
CERN



on behalf of the CLIC Detector and Physics study group

Outline

- The CLIC Accelerator
- Challenges for Detector Design
- The CLIC Detector and Physics Program
 - Simulation Studies
 - Detector Development
- Future Plans
- Summary

CLIC Layout at 3 TeV

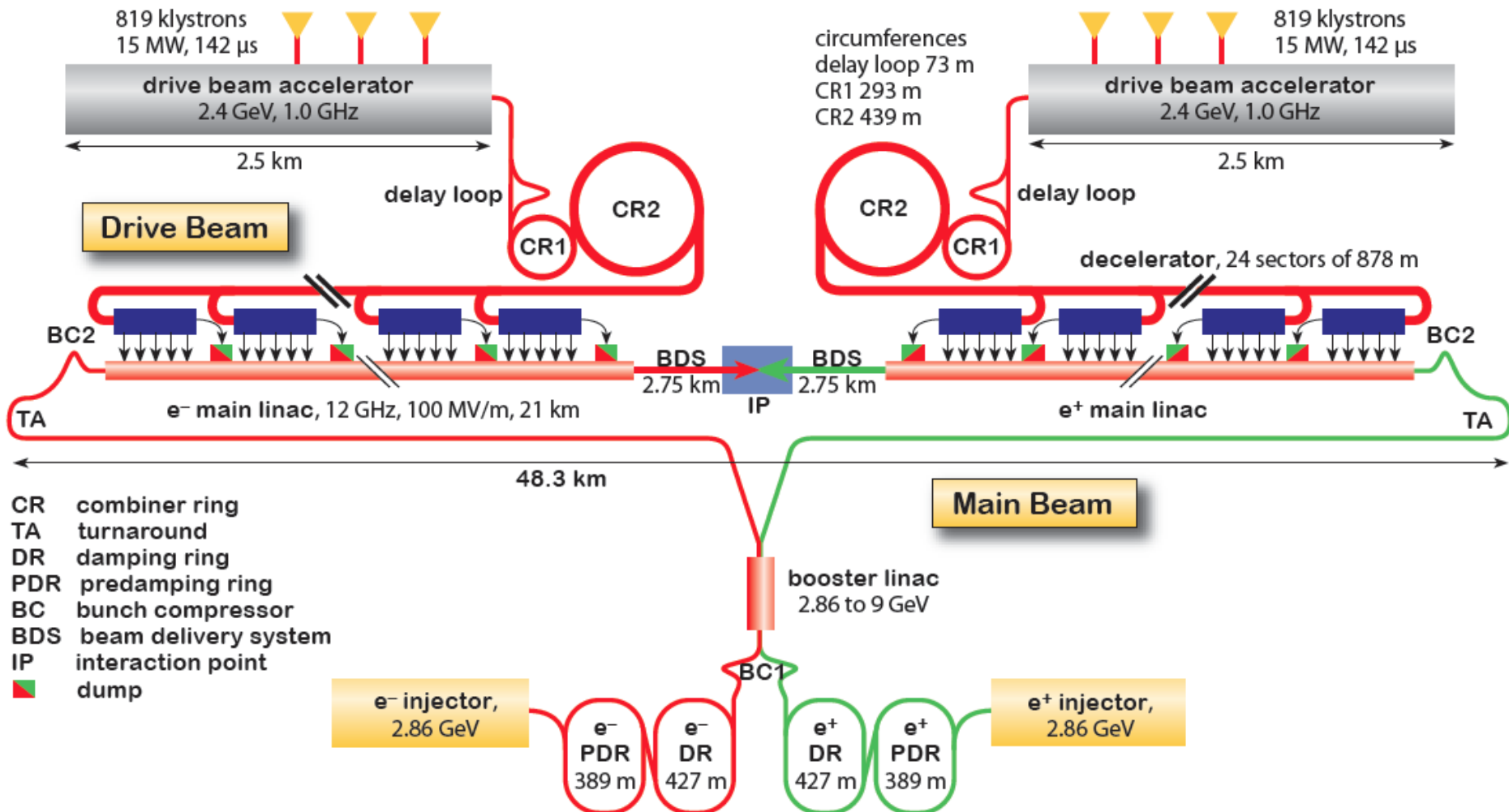

CLIC Layout at 500 GeV

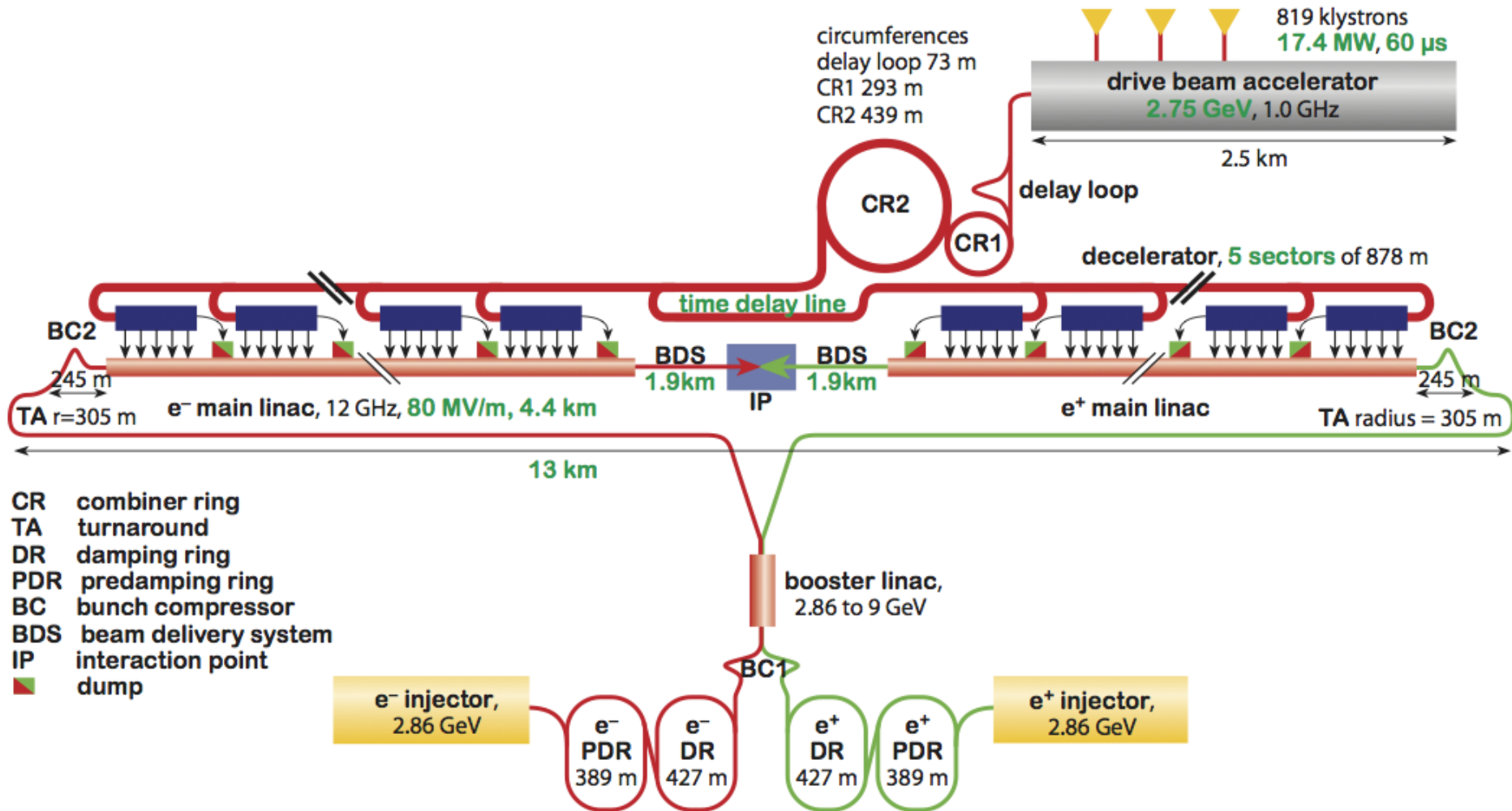

CLIC Staging Scenario

CLIC two-beam scheme compatible with energy staging to provide the optimal machine for a large energy range

Lower energy machine can run most of the time during the construction of the next stage.

Physics results will determine the energies of the stages

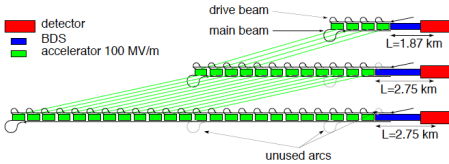
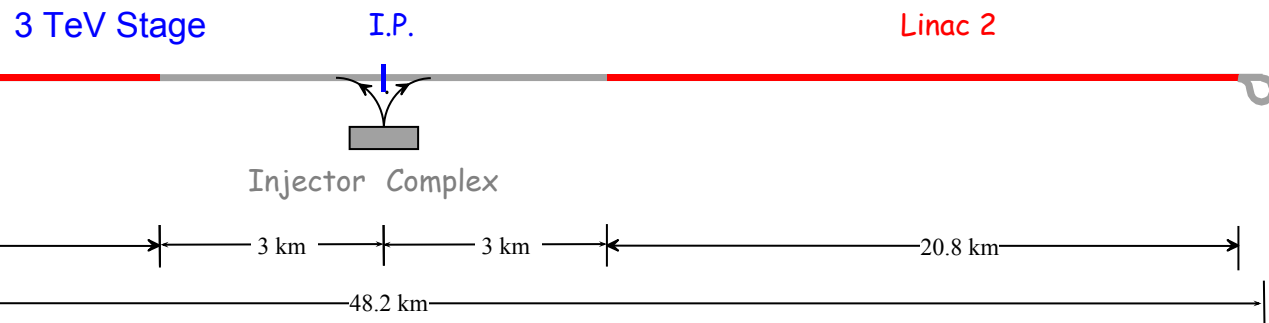
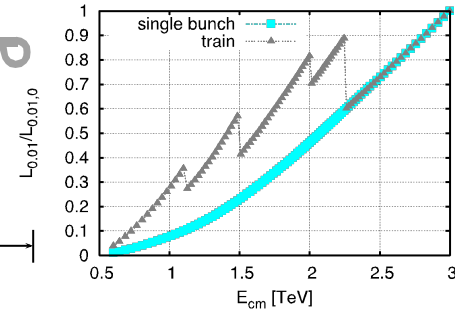
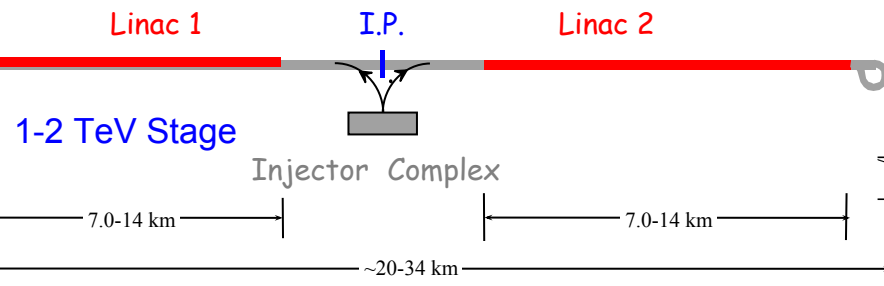
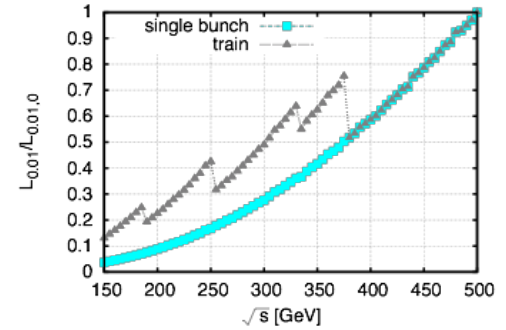
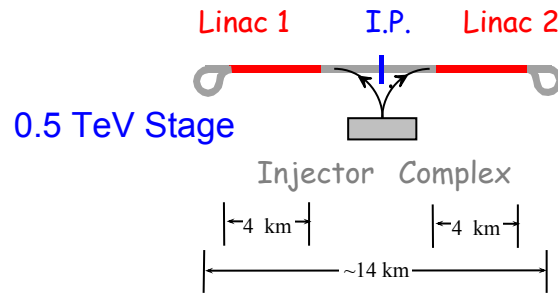

Fig. 3.6: Simplified upgrade scheme for CLIC staging scenario B.

Legend

— CERN existing LHC

Potential underground siting :

●●●● CLIC 500 Gev

●●●● CLIC 1.5 TeV

●●●● CLIC 3 TeV

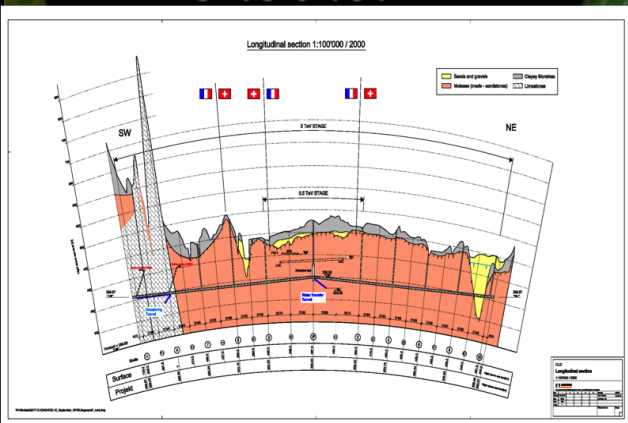

**Tunnel implementations
(laser straight)**

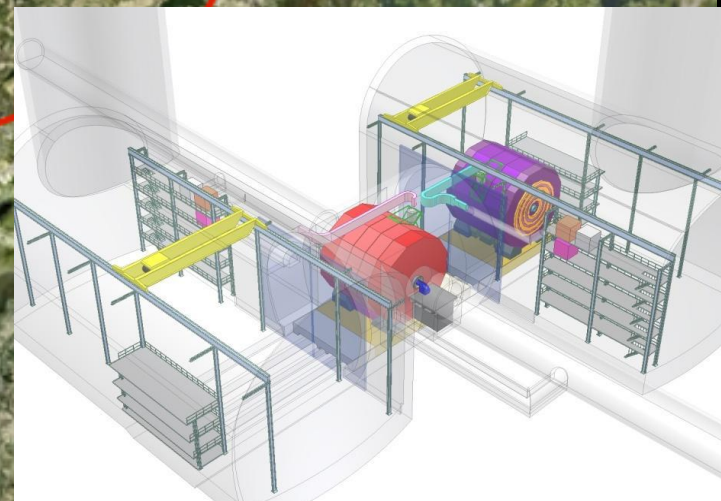
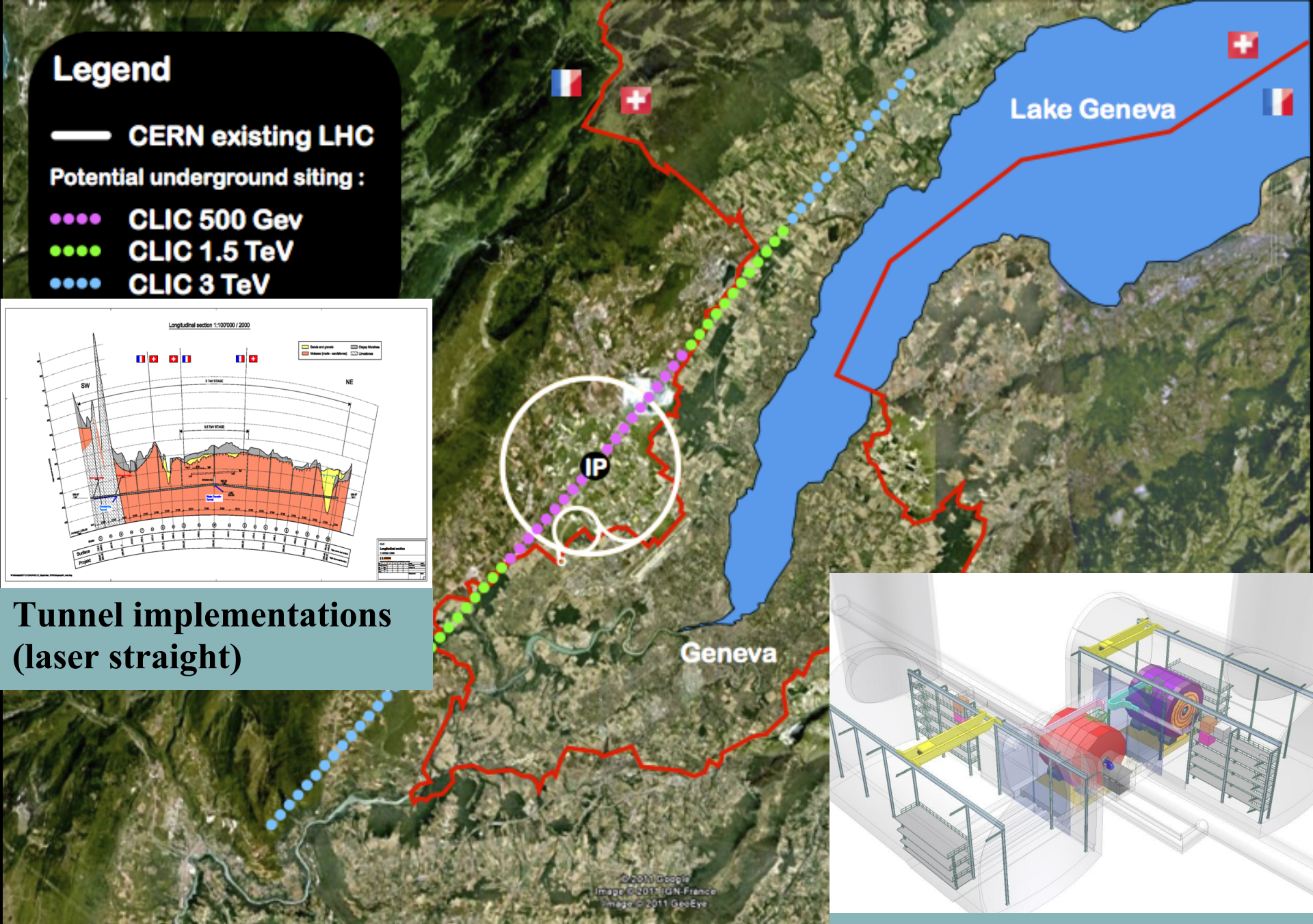

Central MDI & Interaction Region

The CLIC Beams

Parameter	CLIC at 3 TeV
L ($\text{cm}^{-2}\text{s}^{-1}$)	5.9×10^{34}
BX separation	0.5 ns
#BX / train	312
Train duration (ns)	156
Rep. rate	50 Hz
σ_x / σ_y (nm)	$\approx 45 / 1$
σ_z (μm)	44

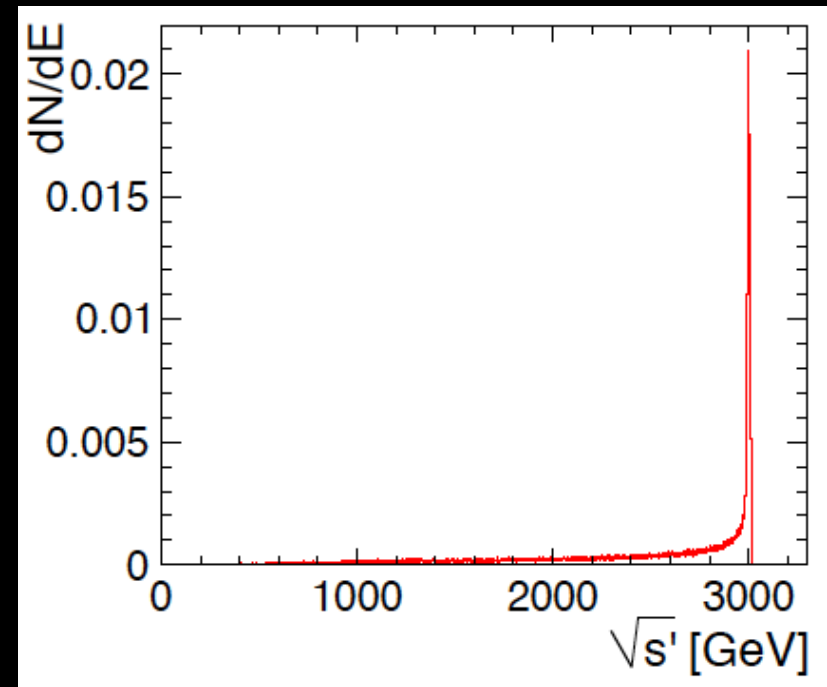

Finite spread of beam energy

Reduction of luminosity

(small effect for processes far from threshold)

Systematic effect on reconstruction,
for example, slepton reconstruction

$\sqrt{s'} / \sqrt{s}$	0.5 TeV	3 TeV
> 99 %	62 %	35 %
> 90 %	89 %	54 %
> 70 %	99 %	76 %
> 50 %	~ 100 %	88 %

Background to Physics studies

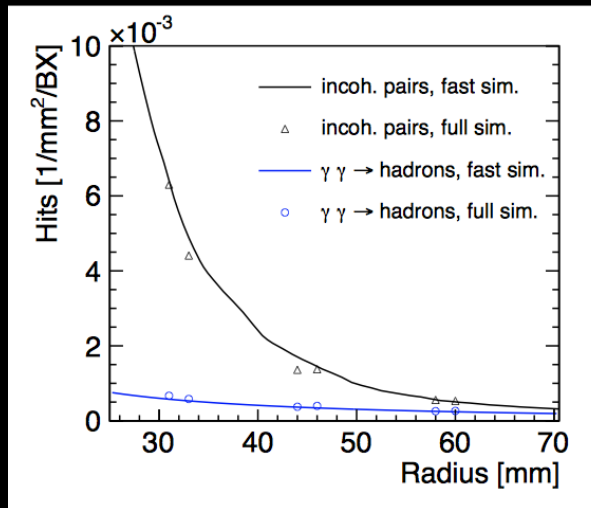
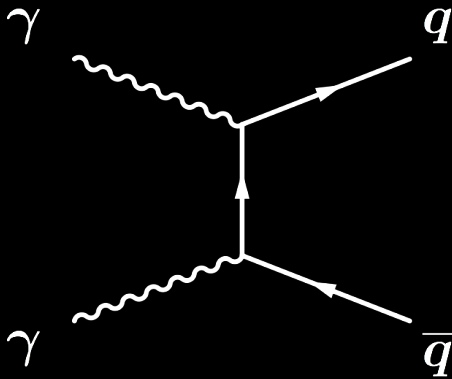

Coherent e^+e^- pairs:

7×10^8 per BX, very forward

Incoherent e^+e^- pairs:

3×10^5 per BX, rather forward

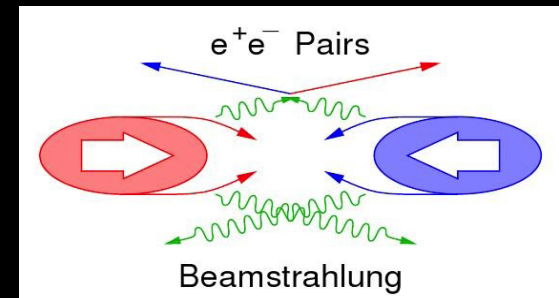

\sqrt{s} (GeV)	$N(\gamma\gamma \rightarrow \text{hadrons})$ per BX
350	0.05
500	0.3
1400	1.3
3000	3.2

Incoherent pair production:

Increases occupancy in inner tracker layers and forward region
 → impact on detector segmentation and pattern recognition

$\gamma\gamma \rightarrow \text{hadrons}$ (at 3 TeV):

Deposit up to 19 TeV of energy in the calorimeters
 ~ 5000 Tracks with 7.3 TeV

Impact is minimized by using advanced reconstruction techniques

Physics Goals Drive Detector Requirements

Momentum resolution

Higgs Recoil, $h \rightarrow \mu^+ \mu^-$:

$$\sigma(p_T)/p_T^2 \sim 2 \times 10^{-5} \text{ GeV}^{-1}$$

Jet Energy Resolution

Separation of heavy bosons,
Gaugino, Triple Gauge Coupling

$$\sigma(E)/E = 3.5\% - 5\%$$

Flavor Tagging

$$\sigma_{r\phi} \approx 5 \mu\text{m} \oplus 15 \mu\text{m} / (p[\text{GeV}] \sin^{\frac{3}{2}} \theta)$$

$h \rightarrow \mu^+ \mu^-$ measurement uncertainty vs. momentum resolution

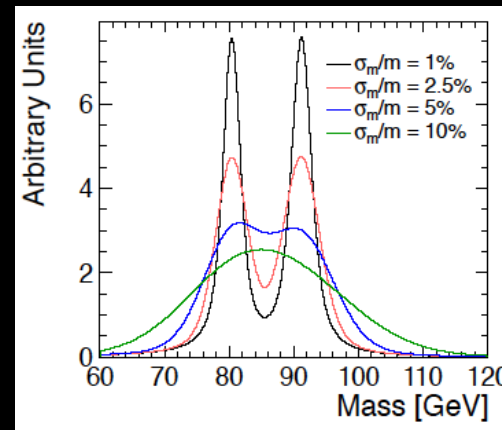
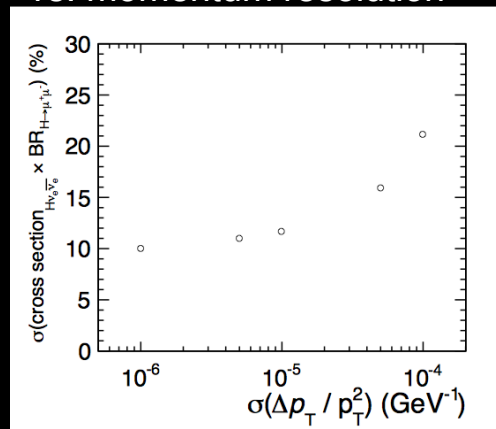

W-Z
separation

Challenges for Detector Design

PFA calorimetry

Calorimeters inside coil (track-shower matching)
Full shower containment for operation at 3 TeV

Tracking

Low material budget
Excellent impact parameter resolution

Forward region

QD0 inside detector \leftrightarrow compact design \leftrightarrow 4π coverage

Detector Concepts for CLIC

CLIC_ILD

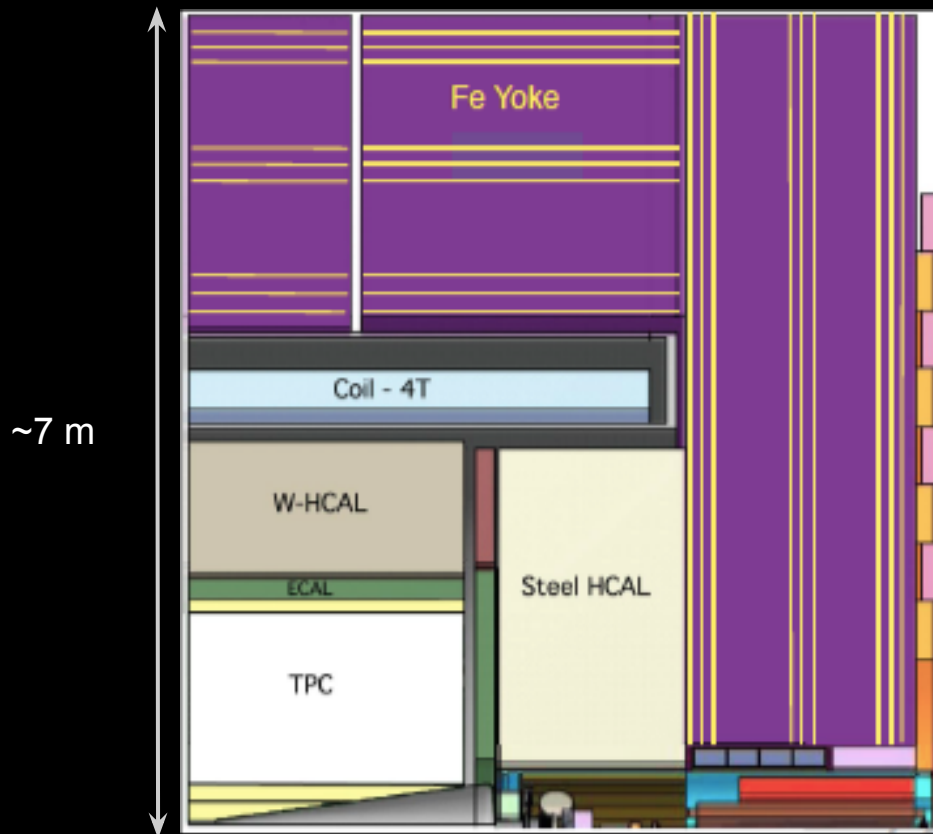

Gaseous Tracking
4 T Field

CLIC_SiD

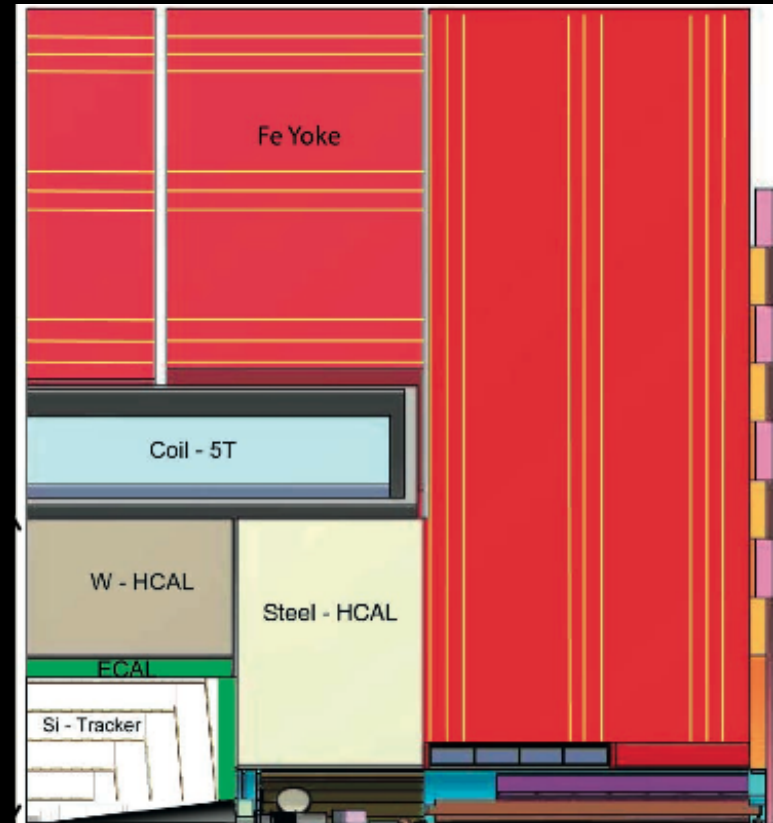

All- Silicon Tracker
5 T Field
Cost-constrained Design

CLIC detector concepts

return yoke with
Instrumentation
for muon ID

complex forward
region with final
beam focusing

strong solenoids
4 T and 5 T

fine grained
calorimetry, $1 + 7.5 \lambda$
30 + 60/75 layers

main trackers:
TPC+silicon (CLIC_ILD)
all-silicon (CLIC_SiD)

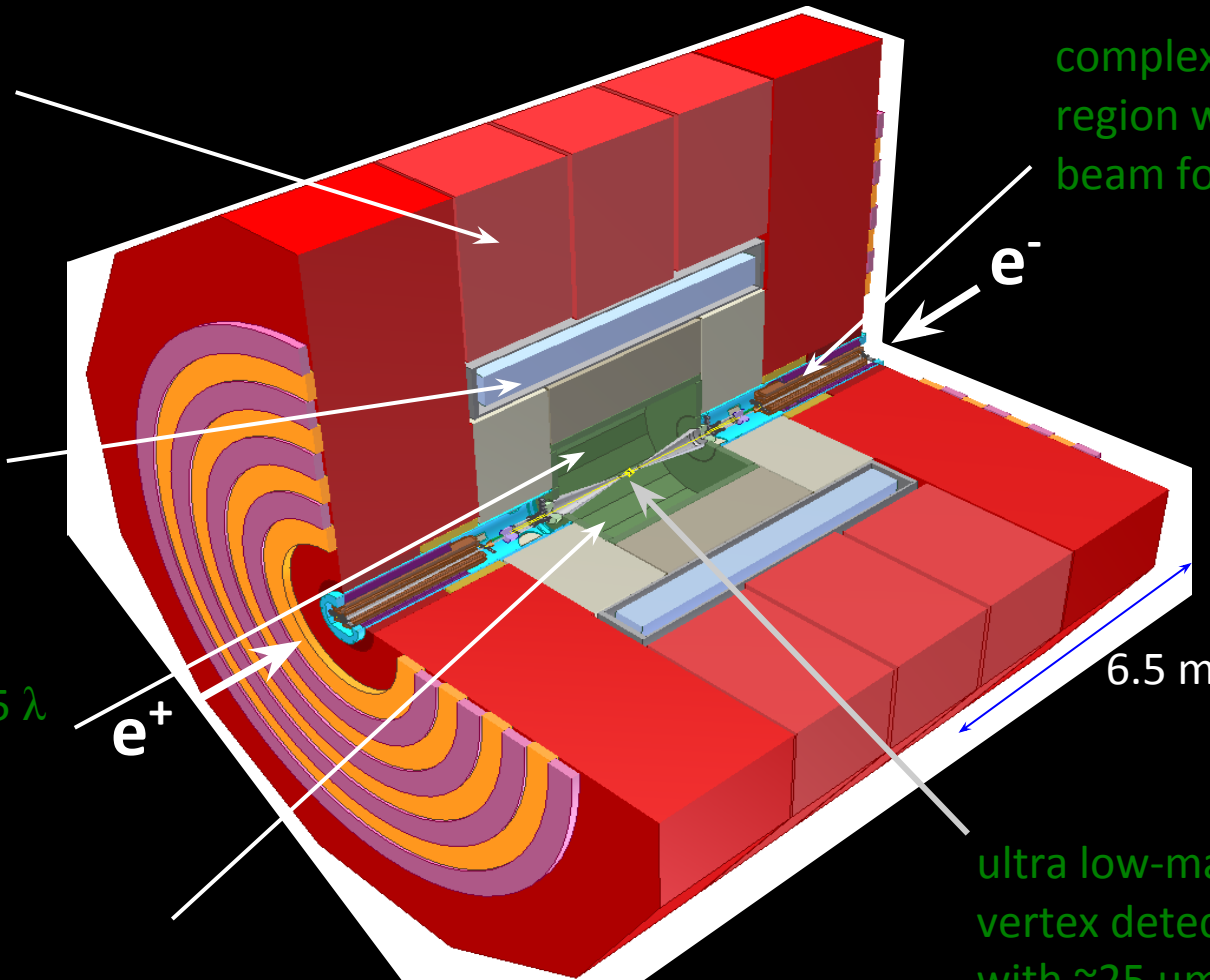

6.5 m

ultra low-mass
vertex detector
with $\sim 25 \mu\text{m}$ pixels

CLIC Detector Concepts Summary

	CLIC_ILD	CLIC_SiD
Vertex Tracker	3 double layers $r_i = 31$ mm	5 layers $r_i = 27$ mm
Tracker	TPC, $r_o = 1.8$ m Silicon envelope	Silicon, $r_o = 1.2$ m
B-field	4 T	5 T
ECAL	SiW $23 X_0$	SiW $26 X_0$
HCAL barrel	W-Scint, 3×3 mm ² 7.5λ	W-Scint, 3×3 mm ² 7.5λ
HCAL endcap	Steel-Scint 7.5λ	Steel-Scint 7.5λ

Introduction to Particle Flow Reconstruction

Typical jet contents:

60% charged particles $\sigma(p_{\perp})/p_{\perp}^2 \sim 2 \times 10^{-5} \text{ GeV}^{-1}$

30% photons $\sigma(E)/E < 20\% / \sqrt{E}$

10% neutral hadrons $\sigma(E)/E > 50\% / \sqrt{E}$

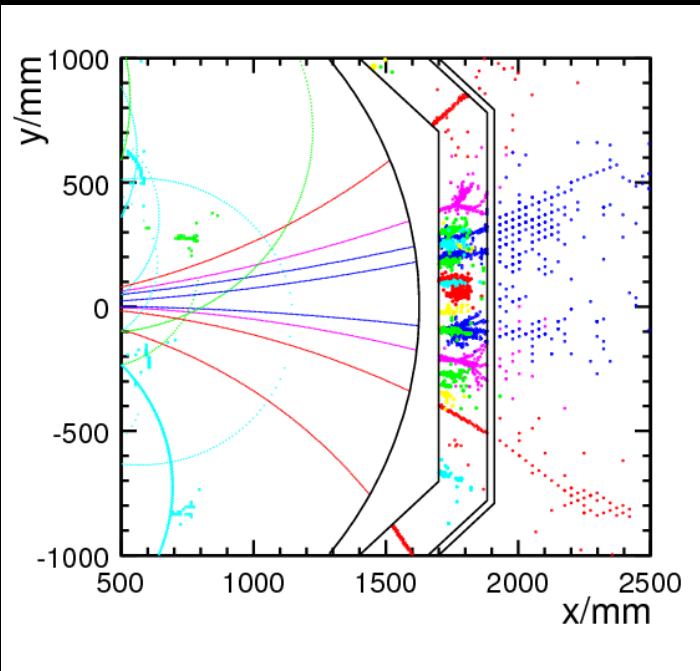

Ideally, fully reconstruct the shower for each particle and match tracks to showers.

At higher jet energies, confusion (mis-matching of energy depositions and particles) deteriorates the resolution.

At even higher energies, leakages becomes a factor in the jet energy resolution.

PFA possible without high granularity

At CLIC: High granularity essential for background reduction

Detector Readout

Triggerless readout of the whole bunch train
Starting time of Physics event inside the train is identified offline



Subdetector	Reco Window	Hit Resolution
ECAL	10 ns	~ 1 ns
HCAL Endcap	10 ns	~ 1 ns
HCAL Barrel	100 ns	~ 1 ns
Silicon Detectors	10 ns	10 ns / $\sqrt{12}$
TPC (CLIC_ILD)	Entire train	n/a

19 TeV \rightarrow 1.2 TeV remaining
in reconstruction window

Passed to track finding and
PFA reconstruction

necessary for development of
shower in tungsten



PFA Calorimetry at CLIC

1.2 TeV "extra energy" in reco window

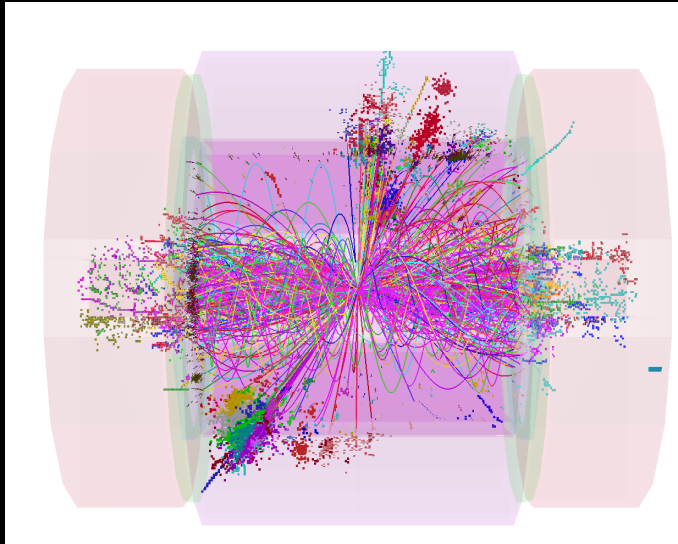

100 GeV "extra energy" after timing cuts

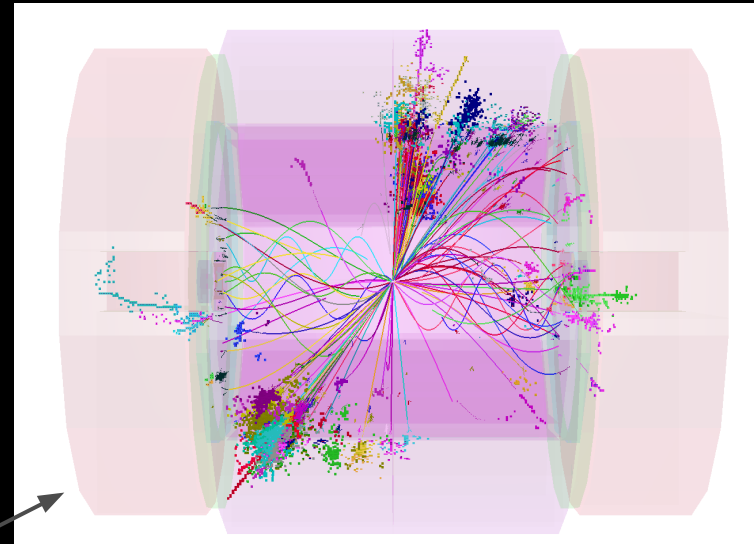

20
BX

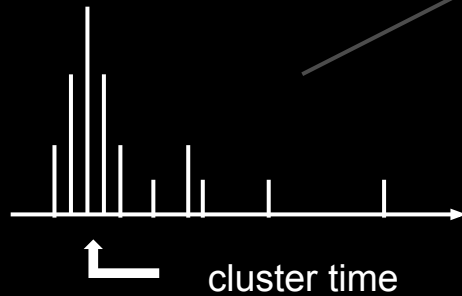

Combination of
time and p_T cuts

3 sets of cuts defined: loose, default, tight

Jet Finding at CLIC

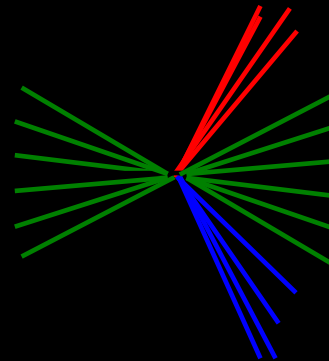
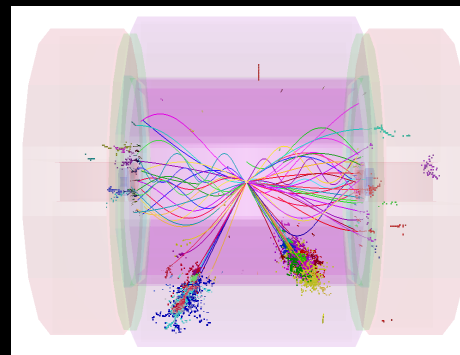
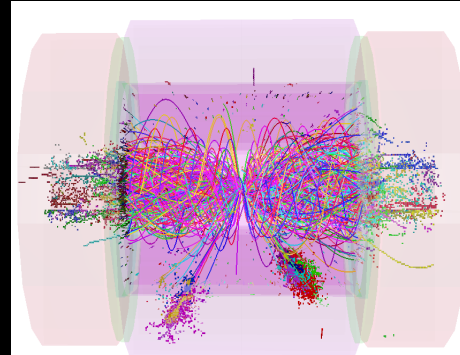
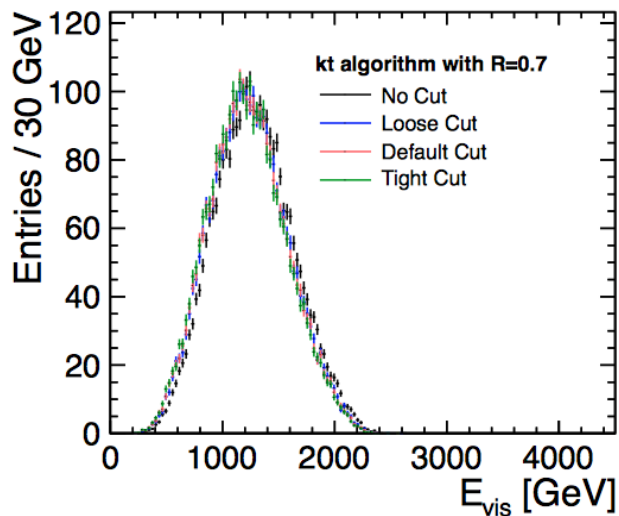
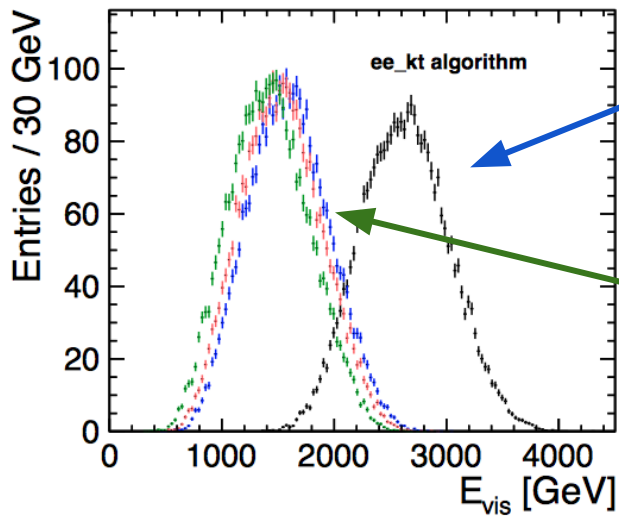

Durham - style jet finders used in exclusive mode

sensitive to background

Analyses in CDR used k_T algorithm as implemented in FastJet

"Beam Jets" pick up most of the forward boosted background

Flavor Tagging at CLIC

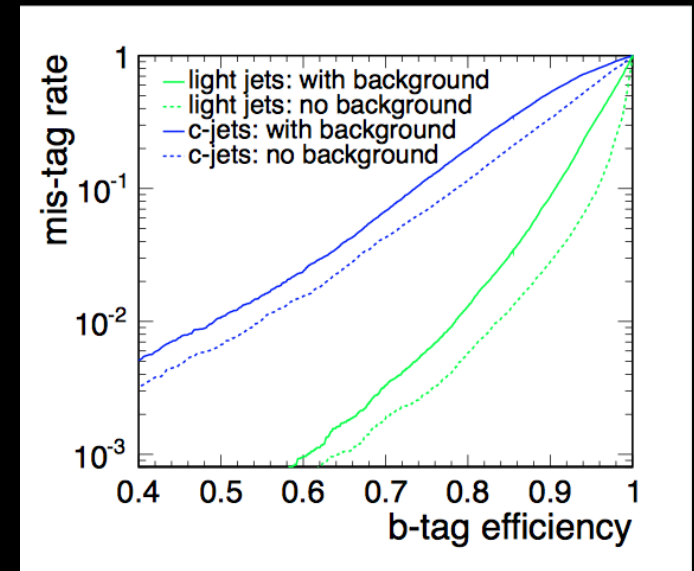
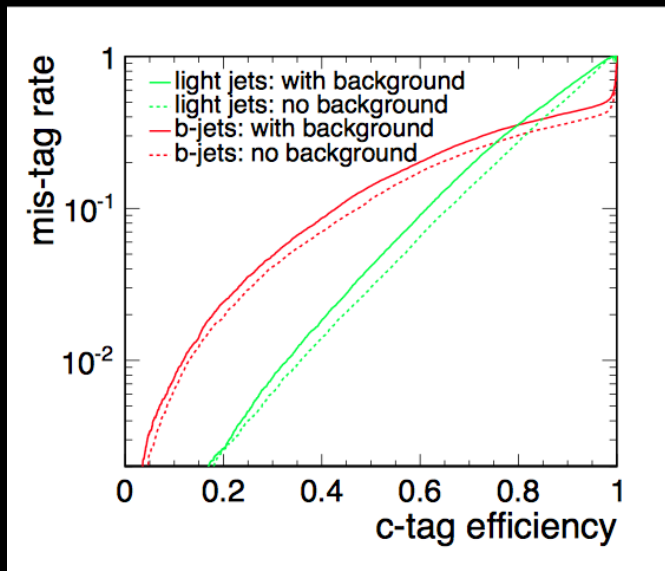

Efficient tagging of b- and c-jets is a crucial component of the Higgs program at a linear collider

Using (basically) the ZVTOP algorithm as implemented by the LCFI collaboration

Background somewhat deteriorates the tagging efficiency

Reconstruction Summary

Intense beams at CLIC pose a challenge for the reconstruction:

19 TeV additionally deposited in the calorimeters

Three ways to reduce impact:

1. Reconstruction time slice:

Identify interesting event offline and remove out-of-time hits

2. Reconstructed particle time:

Compute the time of the particle from the (energy-weighted) average of the calorimeter hits. Remove low- p_T , late arriving particles

3. Jet reconstruction:

Beam jets pick up a lot of the forward-boosted background

Physics Studies at CLIC

Studies have been done with detailed detector simulation

Background taken into account

- (Standard Model) Higgs Studies
- Studies of Physics
Beyond the Standard Model

Higgs Physics at CLIC

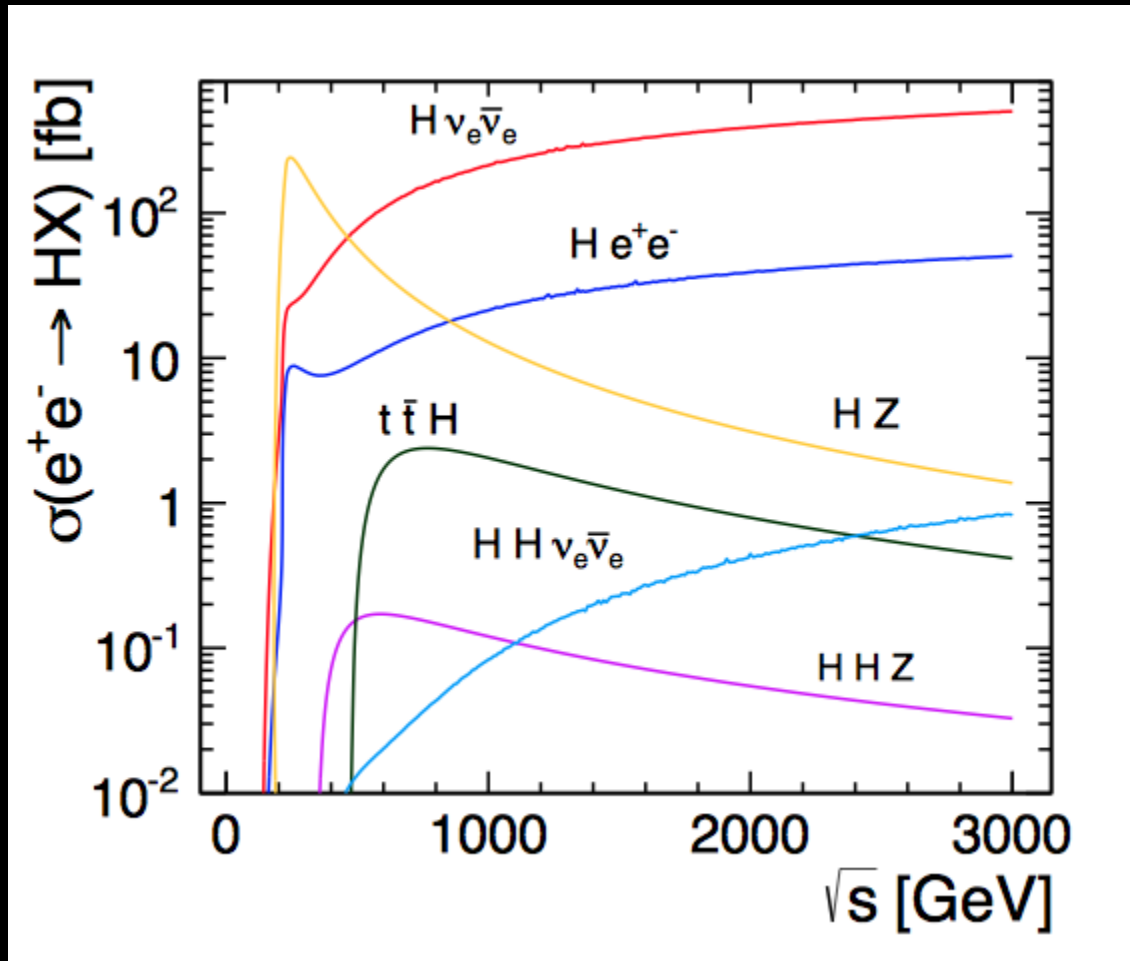

Higgs Physics at CLIC

Higgs Recoil method: First sensitivity to invisible decays

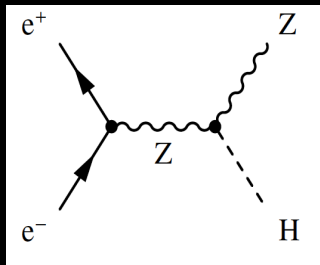

Top Yukawa coupling

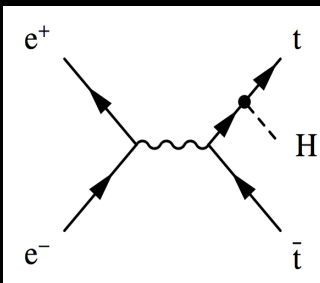

Higgs width

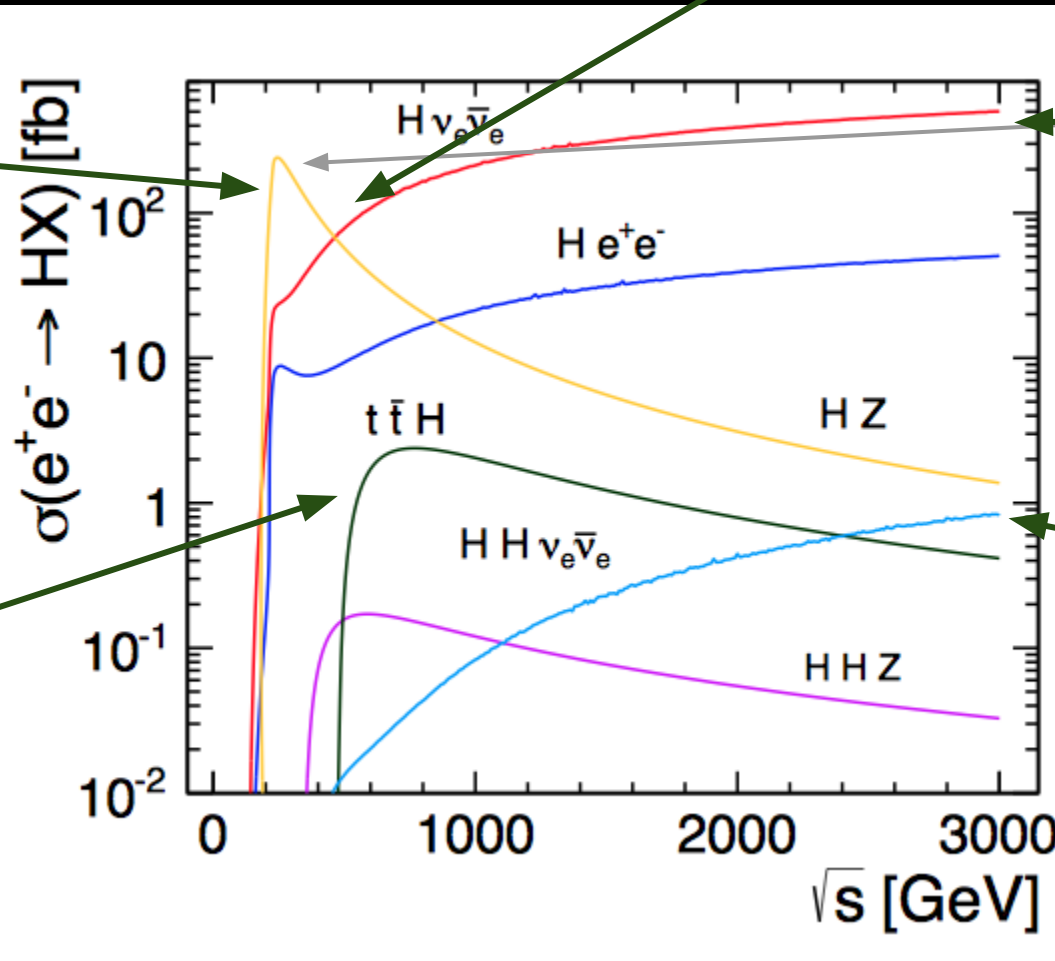

Higgs BR: second generation fermions c quarks, muons

Higgs self-coupling: < 20%

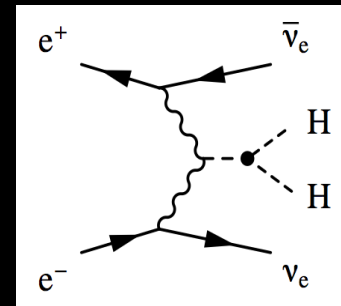
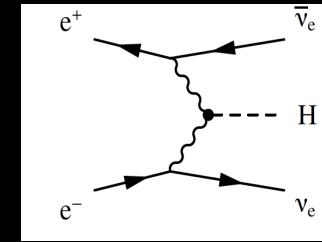

Higgs Recoil Method

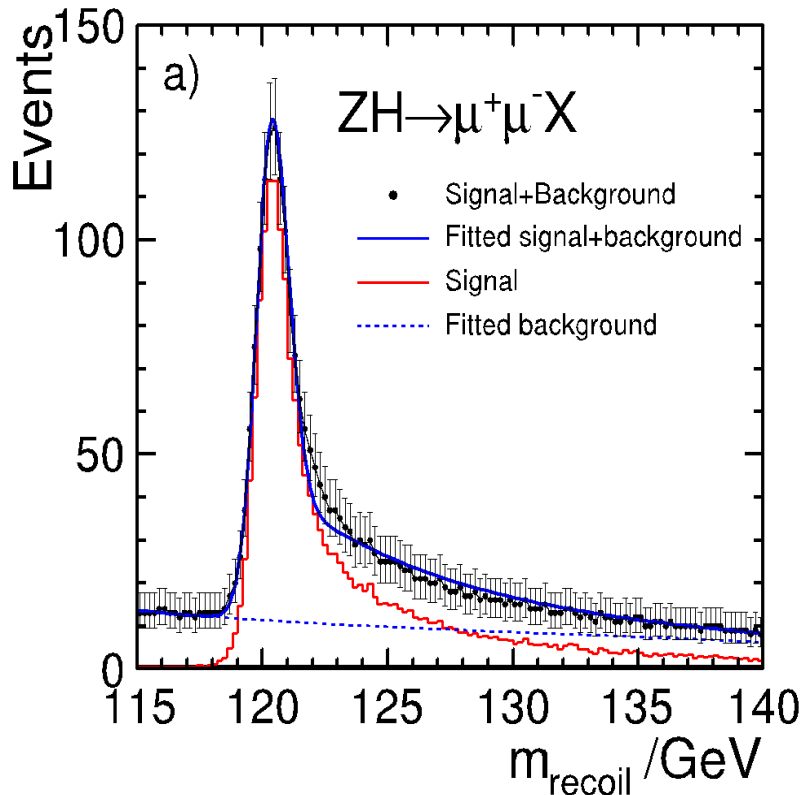
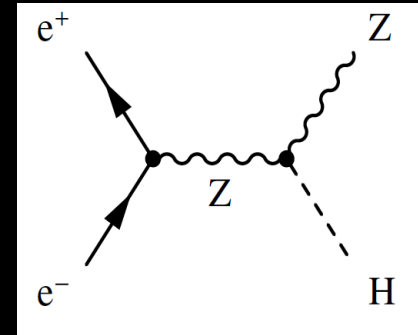

Reconstruct the Z in the di-muon channel

Well-known value for E_{CM} allows to plot the recoil against the Z

No information about the Higgs decay enters this plot
 → sensitivity to invisible decays

Absolute measurement of gauge coupling, limited only by beamstrahlung

$$\frac{\Delta\sigma}{\sigma} \approx 4\% \quad \frac{\Delta g_{\text{HZZ}}}{g_{\text{HZZ}}} \approx 2\%$$

only statistical uncertainty quoted

Higgs BR measurements at 3 TeV

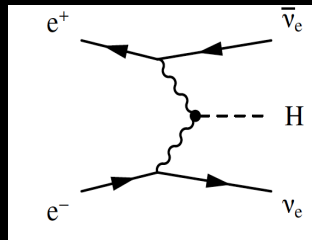

GEANT4-based detector simulation studies
 Realistic simulation of pile-up background
 achievable measurement uncertainty on
 $h \rightarrow b\bar{b}$: 0.22% $h \rightarrow \mu\mu$: 15%
 $h \rightarrow c\bar{c}$: 3.2%

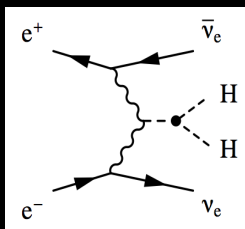
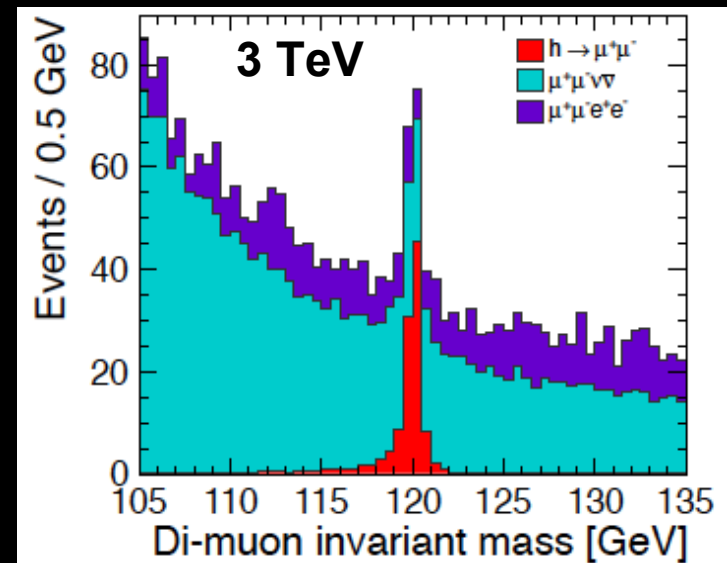
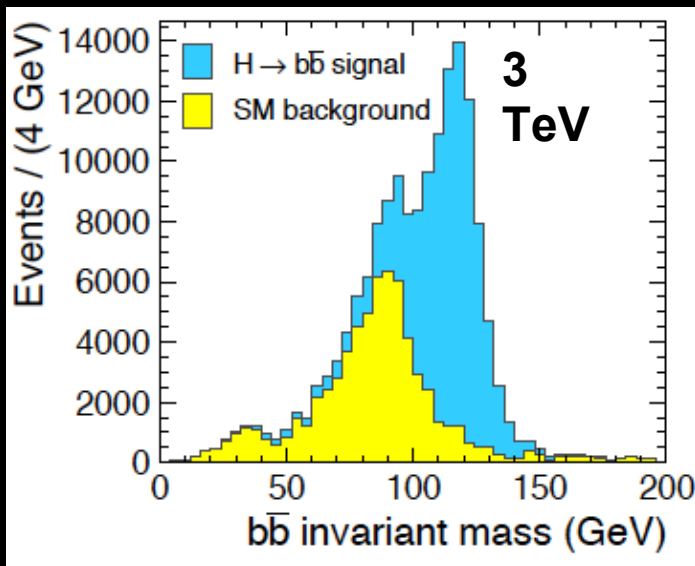

tri-linear self-coupling: ~20% (in progress)

Physics Beyond the Standard Model

First stage defined by physics
350 GeV / 500 GeV
(Higgs, top)

Later stages guided by future
observations

Staging scenario A:
Stage 1: 500 GeV
Stage 2: 1400 GeV
Stage 3: 3000 GeV

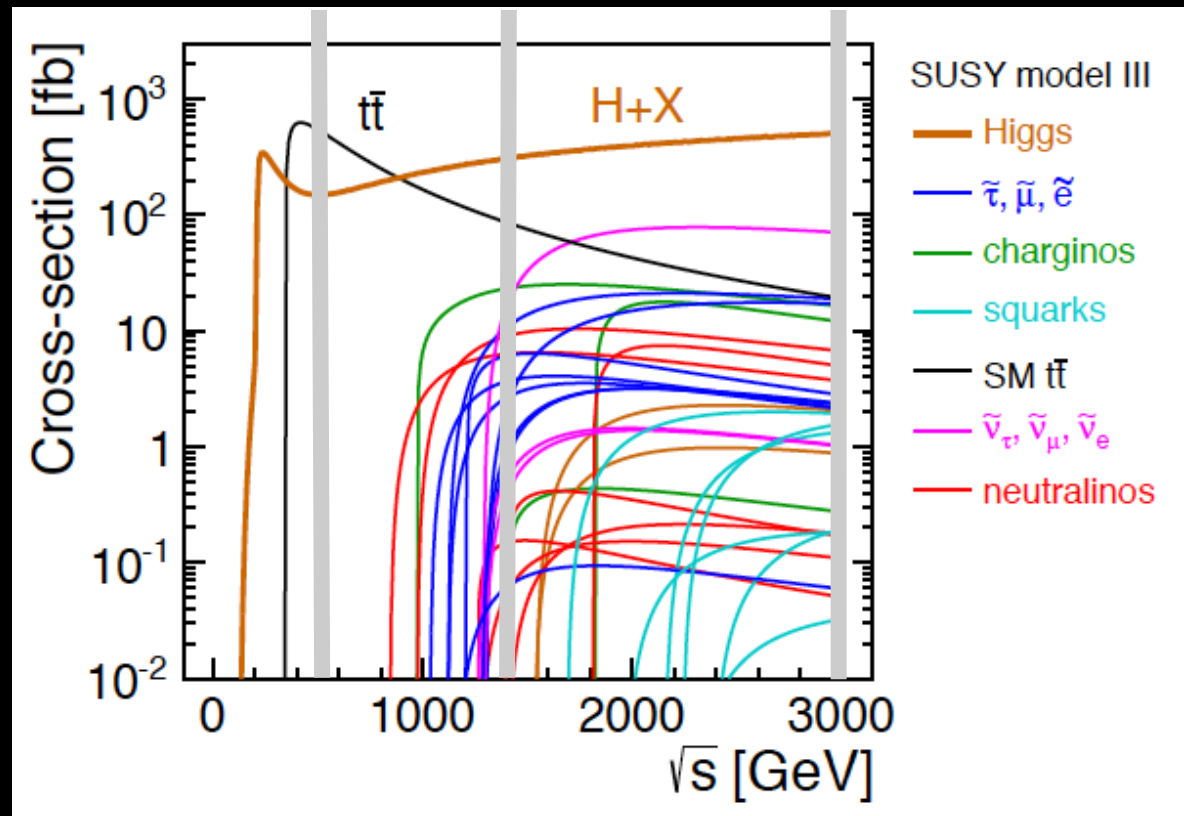

Gaugino Pair Production

$$e^+e^- \rightarrow \tilde{\chi}_1^+ \tilde{\chi}_1^- \rightarrow \tilde{\chi}_1^0 \tilde{\chi}_1^0 W^+ W^-$$

$$e^+e^- \rightarrow \tilde{\chi}_2^0 \tilde{\chi}_2^0 \rightarrow \tilde{\chi}_1^0 \tilde{\chi}_1^0 hh$$

$$e^+e^- \rightarrow \tilde{\chi}_2^0 \tilde{\chi}_2^0 \rightarrow \tilde{\chi}_1^0 \tilde{\chi}_1^0 Zh$$

Signature: 4 Jets + missing Energy

Separation of heavy bosons based on
reconstructed invariant mass

$$\begin{aligned} \sigma(\tilde{\chi}_1^+ \tilde{\chi}_1^-) &= 10.6 \text{ fb} \pm 0.25 \text{ fb} \\ m(\tilde{\chi}^\pm) &= 643.2 \text{ GeV} \pm 7 \text{ GeV} \\ \sigma(\tilde{\chi}_2^0 \tilde{\chi}_2^0) &= 3.3 \text{ fb} \pm 0.11 \text{ fb} \\ m(\tilde{\chi}_2^0) &= 643.1 \text{ GeV} \pm 10 \text{ GeV} \end{aligned}$$

only statistical uncertainty quoted

Detailed Detector Simulation including background
3 TeV CLIC

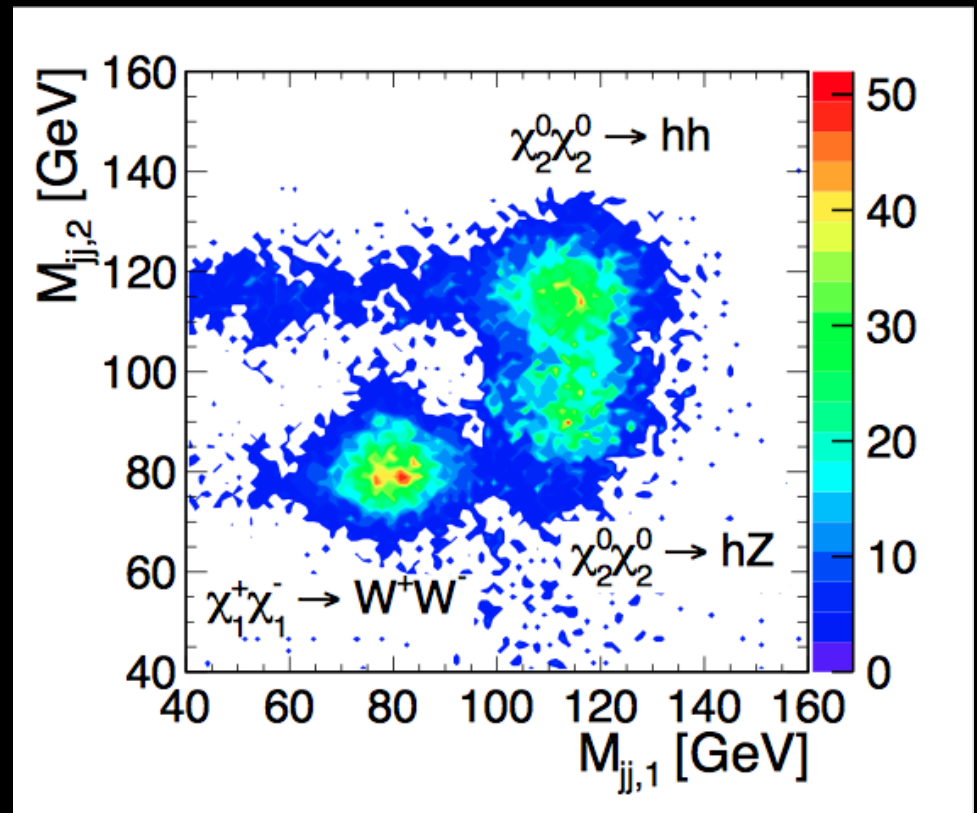

Heavy Higgs Bosons

Test of flavor tagging in boosted jets and reconstruction of high-energy jets

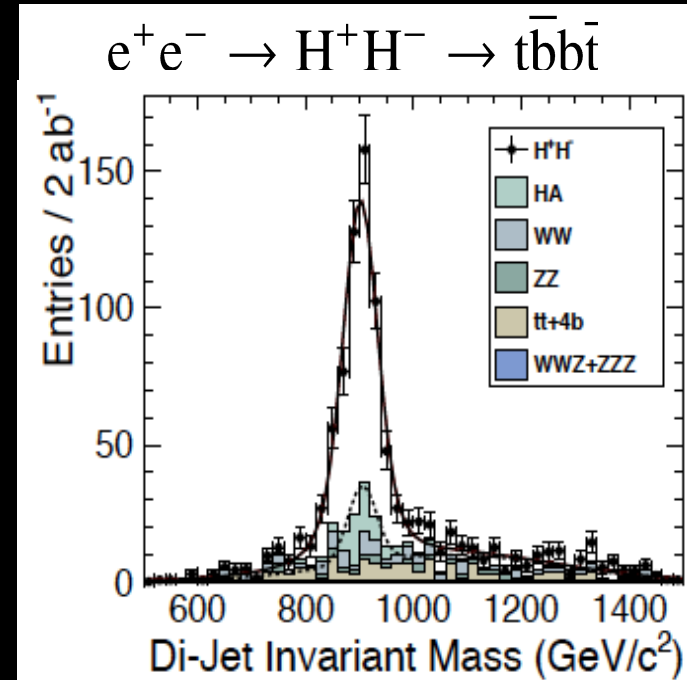
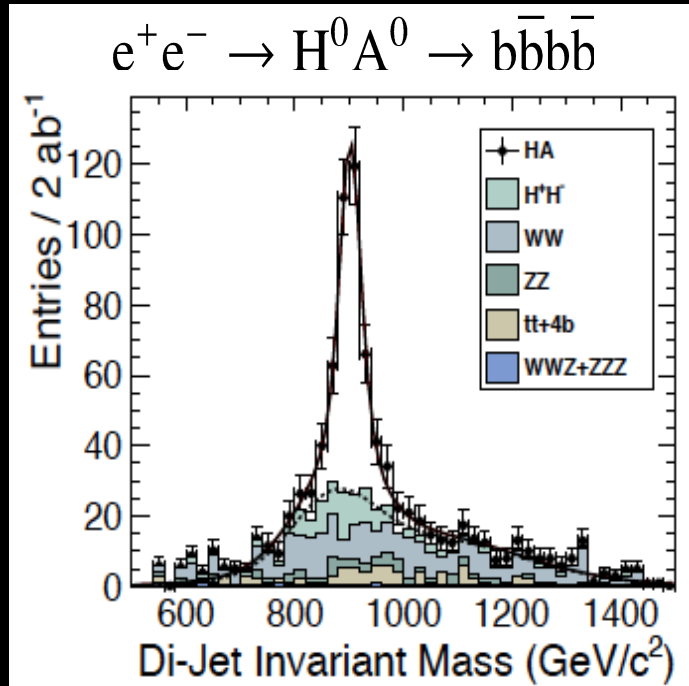

$$m(H^+/H^-) = 906.3 \text{ GeV} \pm 2.4 \text{ GeV} \quad 1.1 \text{ fb}$$

$$m(A^0/H^0) = 902.4 \text{ GeV} \pm 2.8 \text{ GeV} \quad 0.5 \text{ fb}$$

Sensitivity nearly up to $1/2 \sqrt{s}$

only statistical uncertainty quoted

Physics Summary

The CLIC environment at 3 TeV presents a unique opportunity for physics at the TeraScale

Detailed simulation studies show that the impact of the background can be controlled

Excellent detector performance allows precision measurements of heavy objects even at 3 TeV

Hardware R&D

Hadronic Calorimeters

Scintillator Plates in W absorber structure

Glass RPC in W absorber structure

Vertex Detector Engineering

Vertex Detector Pixels

Analog HCAL

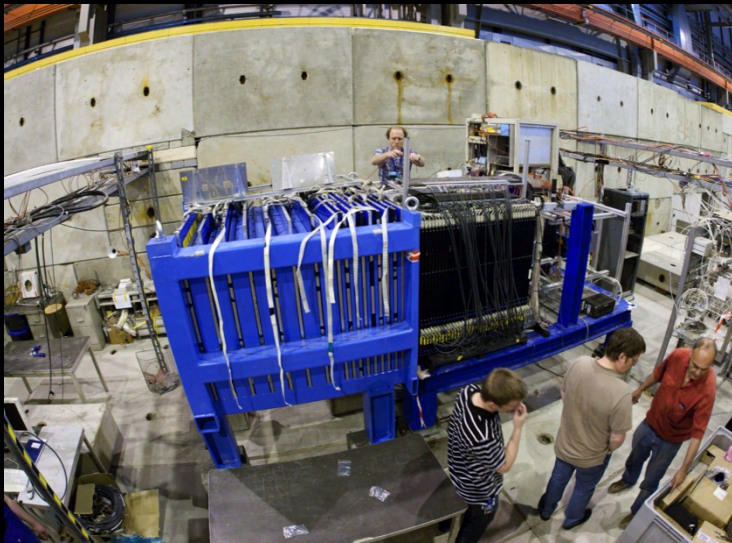

CERN SPS 2011

Validation of GEANT 4 models in tungsten stack

Good agreement found

HCAL tests in 2010+2011

10 mm thick Tungsten absorber plates
scintillator active layers, 3×3 cm² cells

Longitudinal shower profile, pions

visible Energy, protons

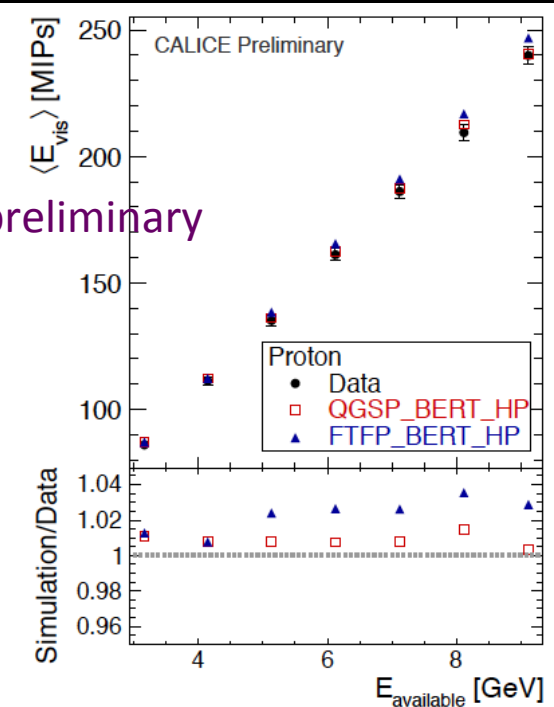
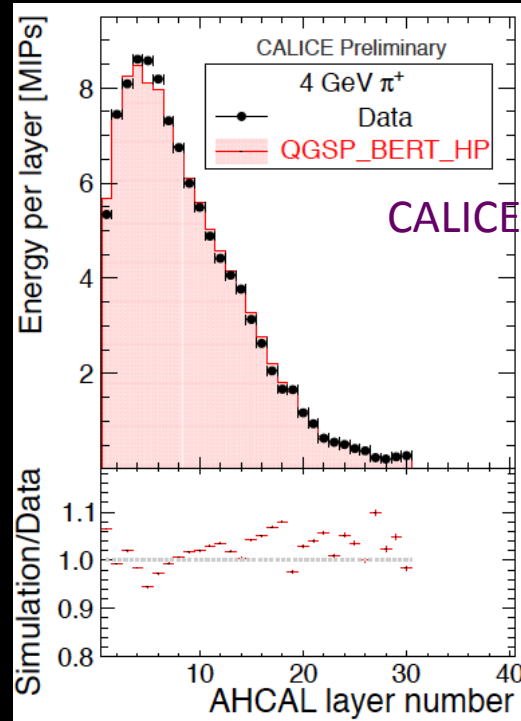

Digital HCAL

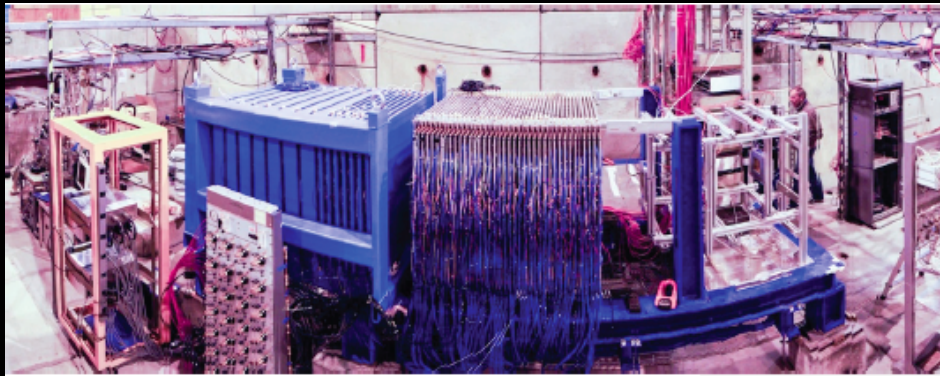

54 glass RPC chambers, 1m² each
PAD size 1x1 cm²
Digital readout (1 threshold)
100 ns time-slicing
Fully integrated electronics
Main DHCAL stack (39) + tail catcher (15)

CERN test setup includes **fast readout RPC (T3B)**

~ 500,000 channels
World record for hadronic calorimetry

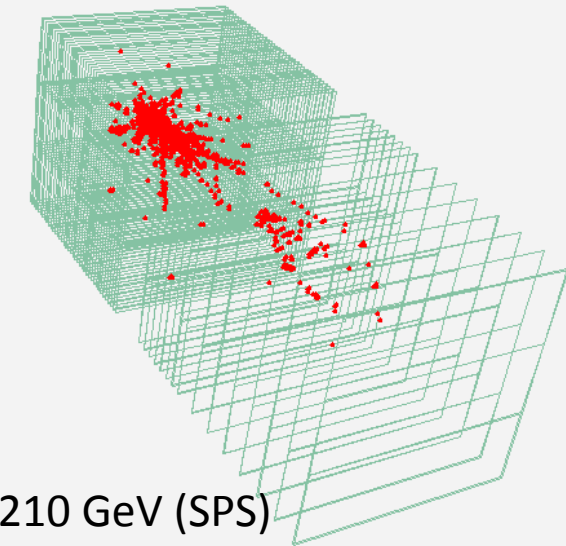
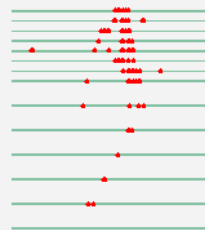
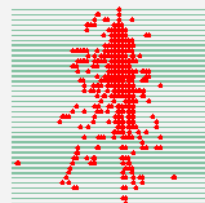
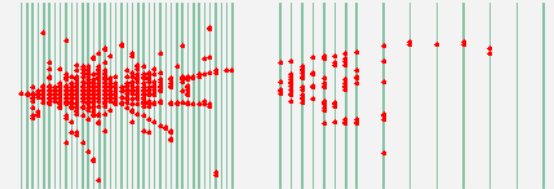
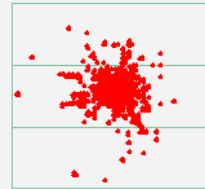

W-DHCAL π^- at 210 GeV (SPS)

Inner Tracking Detectors

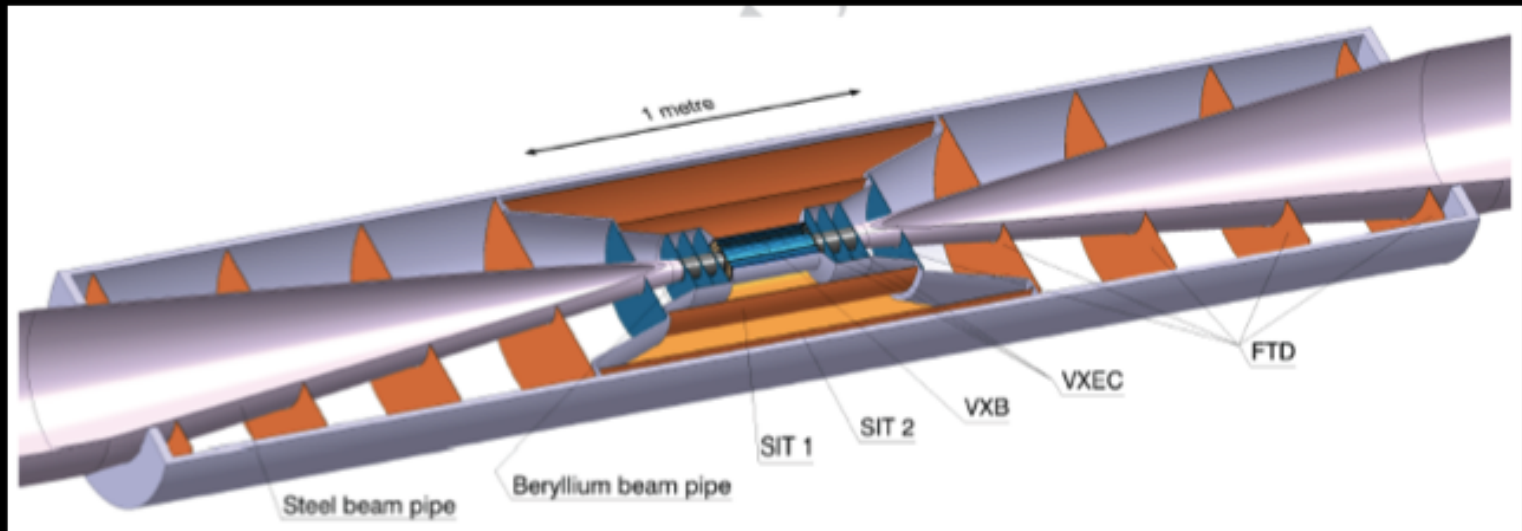

R&D

Material budget goal: $0.2\% X_0$ per layer

Time stamping: 10 ns

Excellent flavor tagging: small pixels $\sim 25 \times 25 \mu\text{m}^2$,
small inner radius (2.7 cm)

Radiation level $< 10^{11} n_{\text{eq}} \text{cm}^{-2} \text{year}^{-1} \leq 10^4$ lower than LHC

Low-mass Cooling

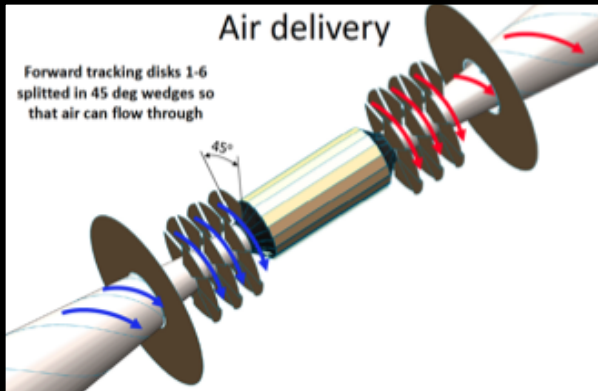

ANSYS finite element simulation of air-flow cooling:
Spiral disk geometry allows for air flow into barrel
Sufficient heat removal

- Temperature $< 30^{\circ}\text{C}$
- Except barrel layer 2 (40°C)
- Conduction not taken into account



Mass Flow: 20.1 g/s
Average velocity:
@ inlet: 11.0 m/s
@ z=0: 5.2 m/s
@ outlet: 6.3 m/s

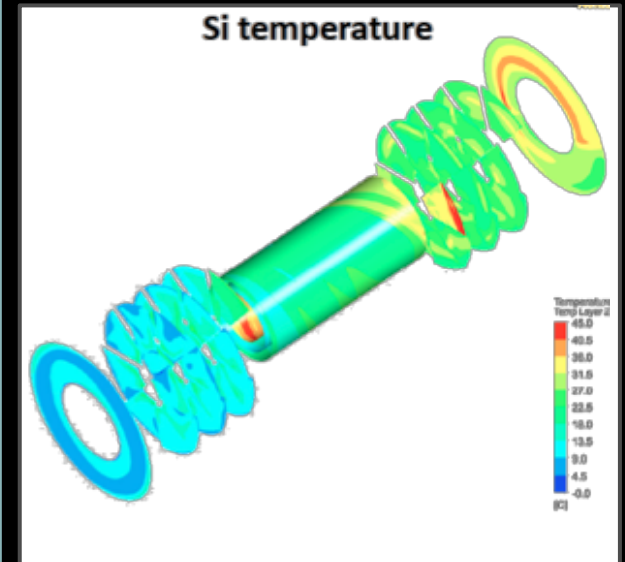

Power Delivery

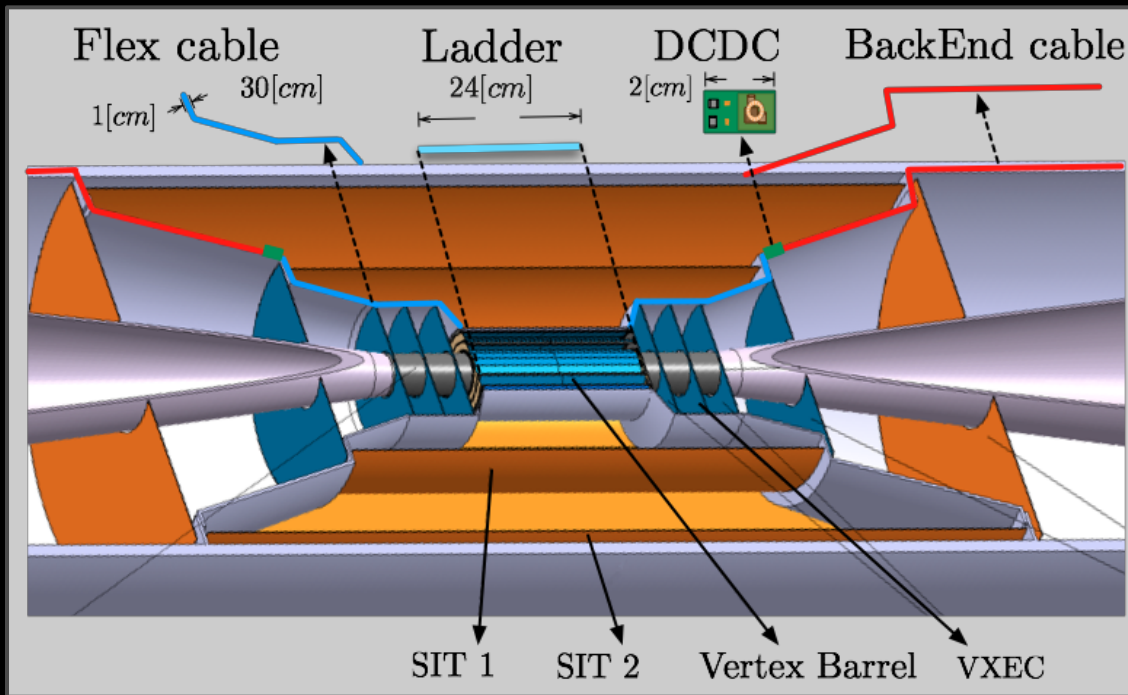

DC/DC converters outside pixel-sensor area

Flexible Kapton cables with Al conductor for power delivery

Power pulsing @ 50 Hz, reducing avg. power

local energy storage and voltage regulation with

Si capacitors ($\sim 10 \mu\text{F}/\text{chip}$) and LDO regulators

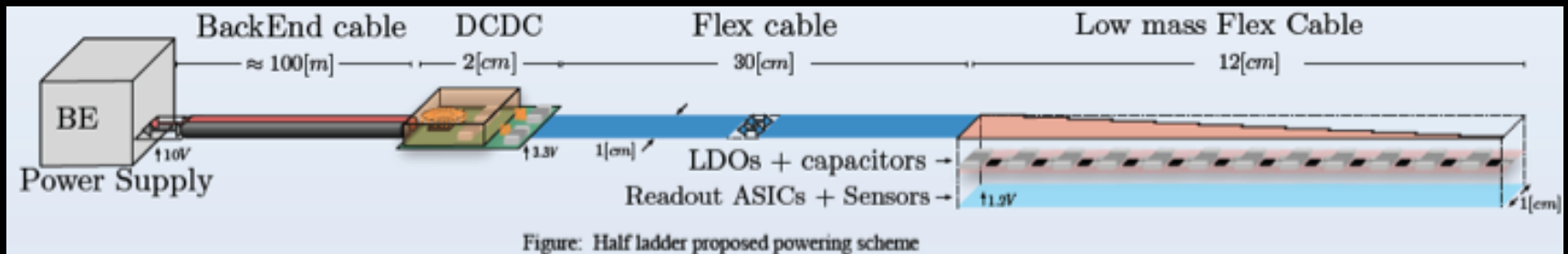
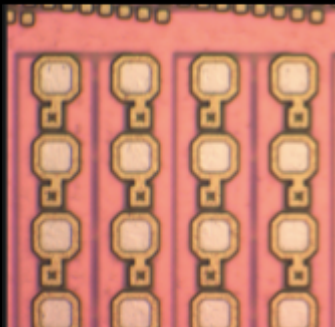
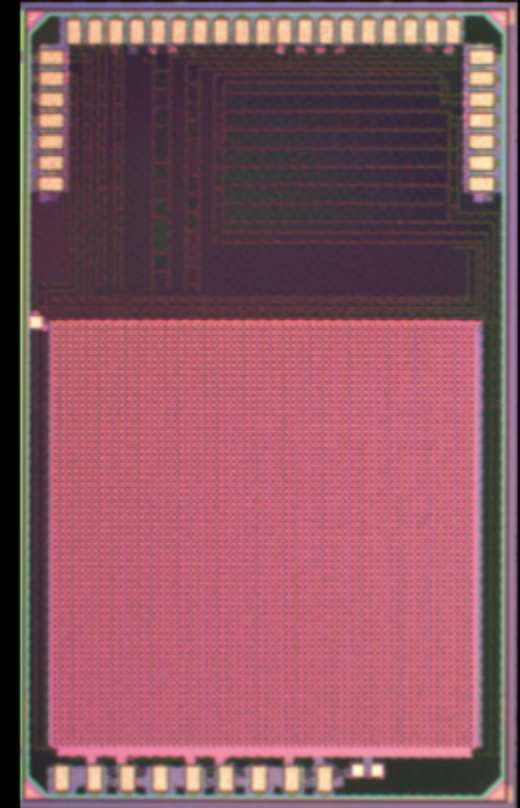

Figure: Half ladder proposed powering scheme

CLICPix demonstrator

Hybrid approach pursued: (\leq other options possible)

- Thin ($\sim 50 \mu\text{m}$) silicon sensors (Micron, CNM, VTT)
- Thinned High density ASIC in very-deep-sub-micron:
- TimePix3, Smallpix \leq R&D steps
- CLICpix
- Low-mass interconnect
- Micro-bump-bonding (Cu-pillar option, Advacam)
- Through-Silicon-Vias (R&D with CEA-Leti)
- Chip-stitching



CLICpix

64×64 pixel demonstrator

- 65 nm technology
- $25 \times 25 \mu\text{m}^2$ pixels
- 4-bit TOA and TOT information
- 10 nsec time-slicing
- Power 2 W/cm^2 (continuous)

With sequential power pulsing 50 mW/cm^2

- **CLIC CDR (#1)**, A Multi-TeV Linear Collider based on CLIC Technology, CERN-2012-003, <https://edms.cern.ch/document/1234244/>
- **CLIC CDR (#2)**, Physics and Detectors at CLIC, CERN-2012-003, [arXiv:1202.5940](https://arxiv.org/abs/1202.5940)
- **CLIC CDR (#3)**, The CLIC Programme: towards a staged e⁺e⁻ Linear Collider exploring the Terascale, CERN-2012-005, [http://arxiv.org/abs/1209.2543](https://arxiv.org/abs/1209.2543)



Organisation of CLIC Detector and Physics study

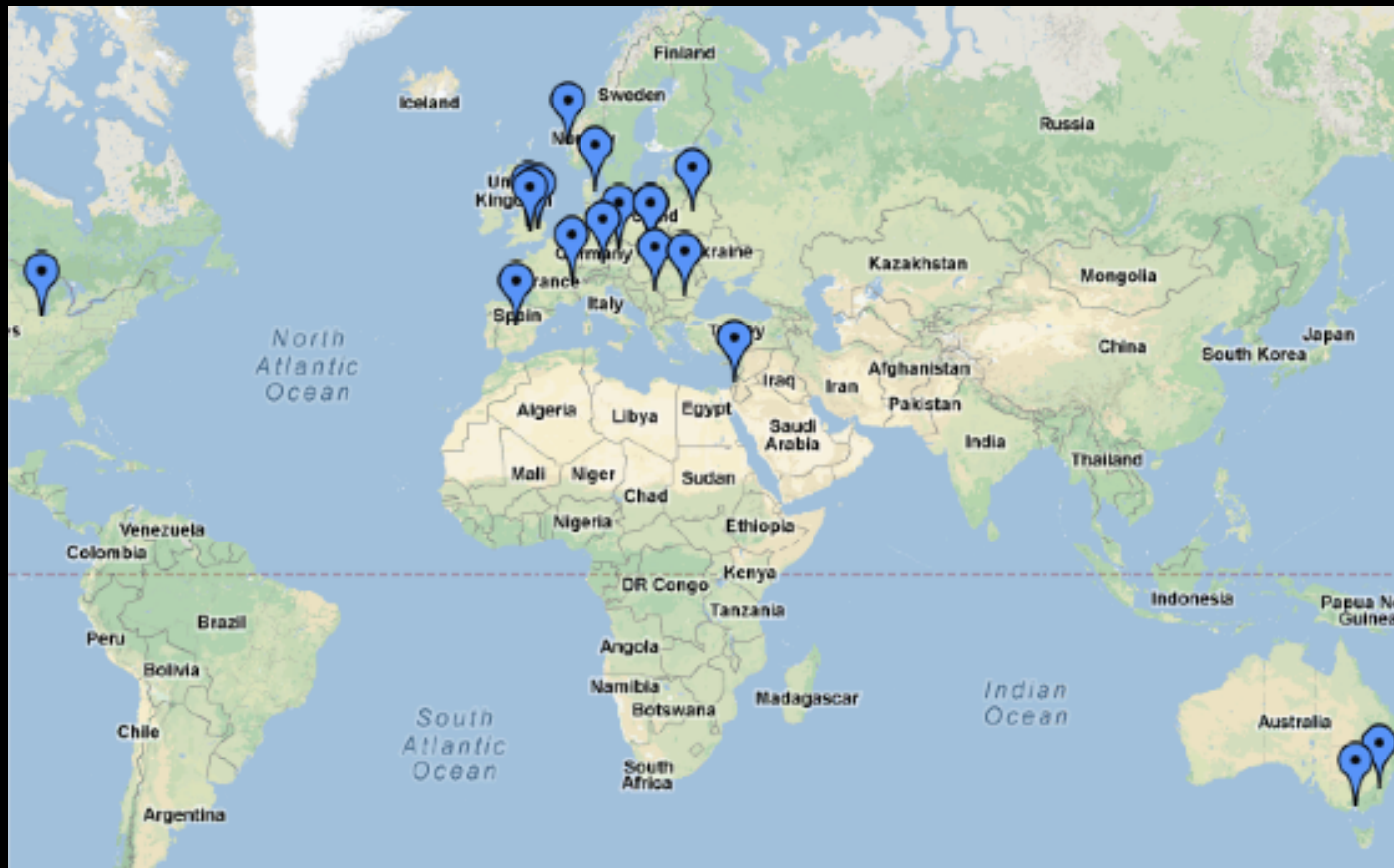

Pre-collaboration structure, based on a “Memorandum on Cooperation”
<http://lcd.web.cern.ch/LCD/Home/MoC.html>

CLIC strategy and objectives



2012-16 Development Phase

Develop a Project Plan for a staged implementation in agreement with LHC findings; further technical developments with industry, performance studies for accelerator parts and systems, as well as for detectors.

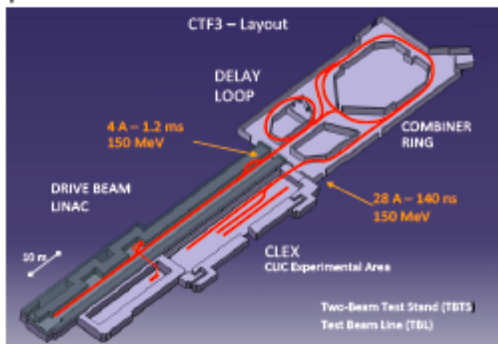

2016-17 Decisions

On the basis of LHC data and Project Plans (for CLIC and other potential projects), take decisions about next project(s) at the Energy Frontier.

2017-22 Preparation Phase

Finalise implementation parameters, Drive Beam Facility and other system verifications, site authorisation and preparation for industrial procurement. Prepare detailed Technical Proposals for the detector-systems.

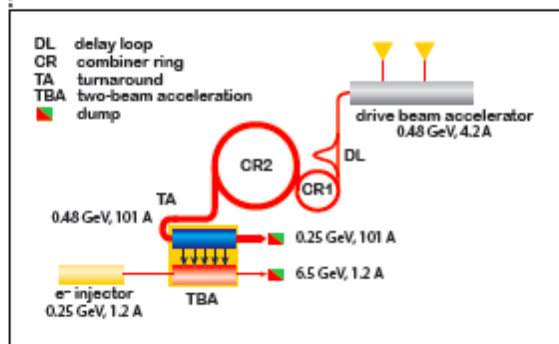

2022-23 Construction Start

Ready for full construction and main tunnel excavation.

2023-2030 Construction Phase

Stage 1 construction of a 500 GeV CLIC, in parallel with detector construction. Preparation for implementation of further stages.

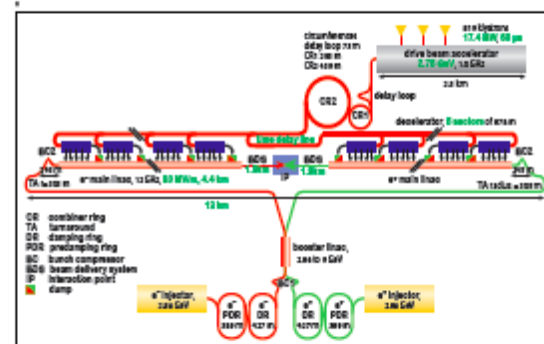

plans for the phase 2013-2016



Further exploration of the physics potential

- Complete picture of Higgs prospects at ~ 350 GeV, ~ 1.4 TeV, ~ 3 TeV
- Discovery reach for BSM physics
- Sensitivity to BSM through high-precision measurements

cf. LHC results



Drives the CLIC staging strategy

Detector Optimisation studies

- Optimisation studies linked to physics (e.g aspect ratio, forward region coverage);
- Interplay between occupancies and reconstruction;
- Interplay between technology R&D and simulation models.

Technology demonstrators

- Many common developments with ILC
- Complemented with CLIC requirements



R&D objectives: 2013-2016



R&D => technology demonstrators

Implementation examples *demonstrating the required functionality*

Vertex detector

Demonstration module, meeting requirements of high precision, 10 ns time stamp and ultra-low mass

Main tracker

Demonstration modules, including manageable occupancies in the event reconstruction

Calorimeters

Demonstration modules, technological prototypes + addressing control of cost

Electronics

Demonstrators, in particular in view of power pulsing

Magnet systems

Demonstrators of conductor technology, safety systems and moveable service lines

Engineering and detector integration

Engineering design and detector integration harmonized with hardware R&D demonstrators

**Challenging and interesting detector technologies
Considered feasible in a 5-year R&D program**

summary and outlook



Summary of CLIC detector & physics CDR studies

- Feasibility of precision physics measurements demonstrated
- Staged implementation of CLIC => large potential for SM and BSM physics

Good progress with understanding detectors at CLIC

- Based on ILD and SiD concepts
- Detector requirements now well understood
- => challenging, but feasible through realistic R&D

Development program for the next CLIC phases

- Anticipating energy frontier machine choice ~2017
- Anticipating start of construction by ~2023

Welcome to join !

lcd.web.cern.ch/lcd/

<http://lcd.web.cern.ch/LCD/Home/MoC.html>

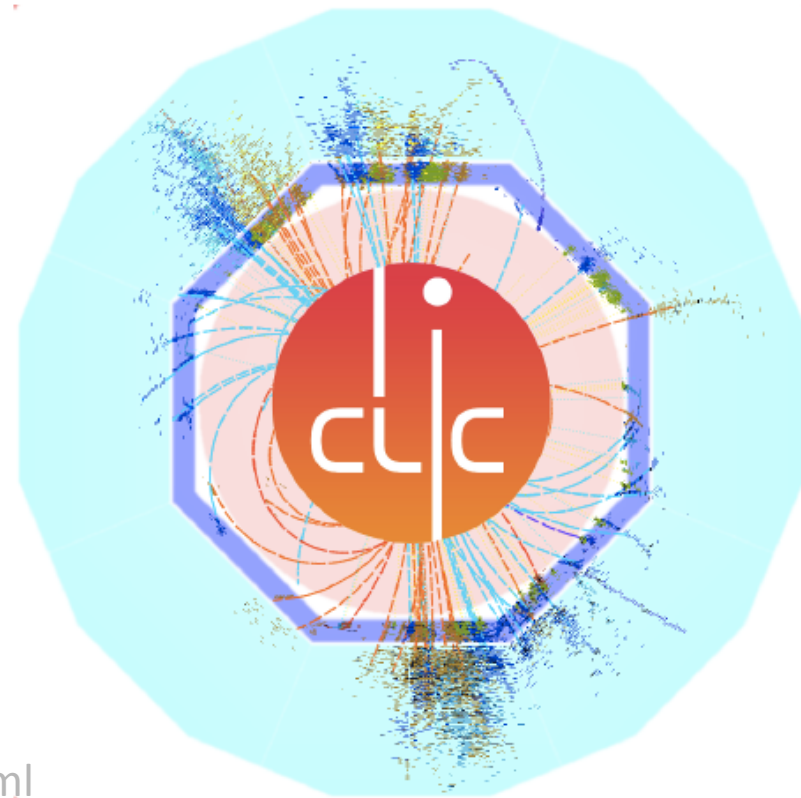

Backup

Power Pulsing Measurements

Test setup with active loads emulating analog pixel F/E:

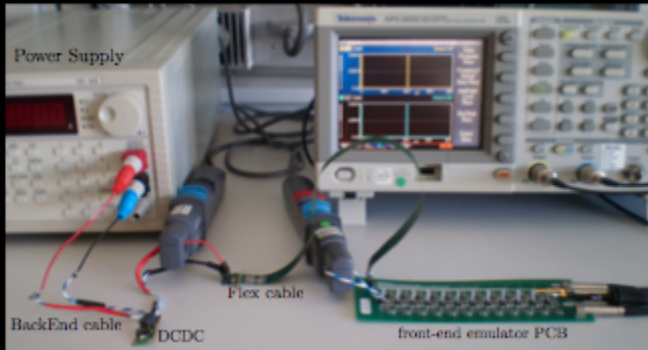

Measurement

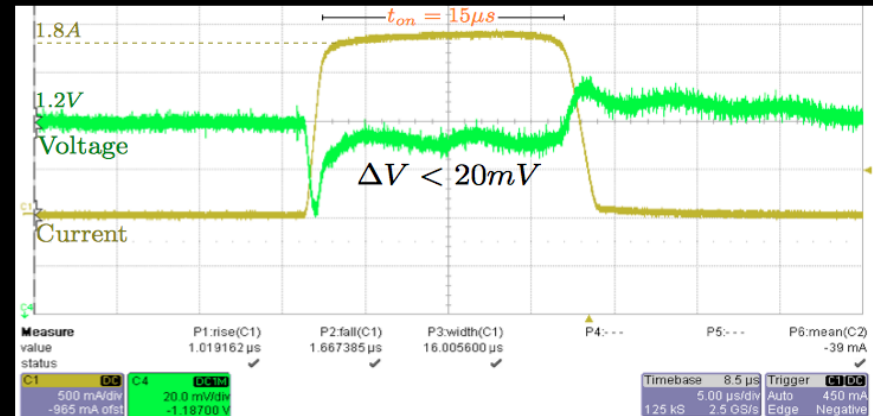

- Equivalent thickness cable+LDO+cap.: 0.145% X0 / layer in vtx region
- Power pulsing at 50 Hz
- Load current of 2 A (half ladder) during 15 μs
- Monitor load voltages and currents
- Observed ripple $\Delta V < 20 mV$, acceptable for CLICPix
- Agreement between measurement and simulation

Simulation

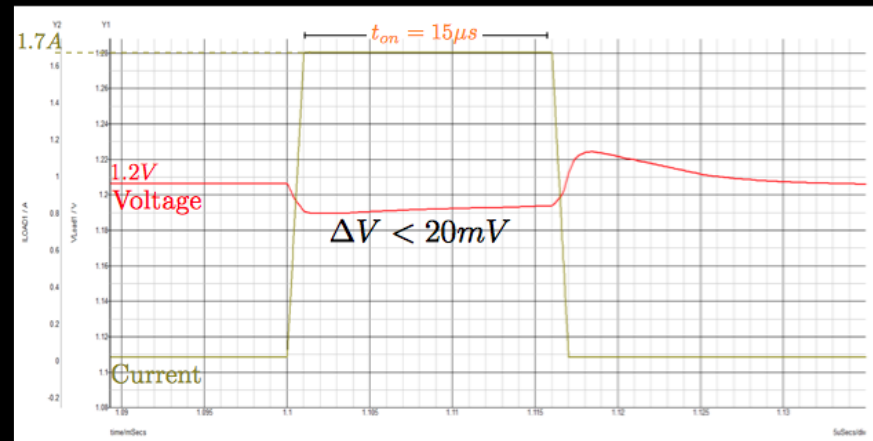

Possible luminosity examples

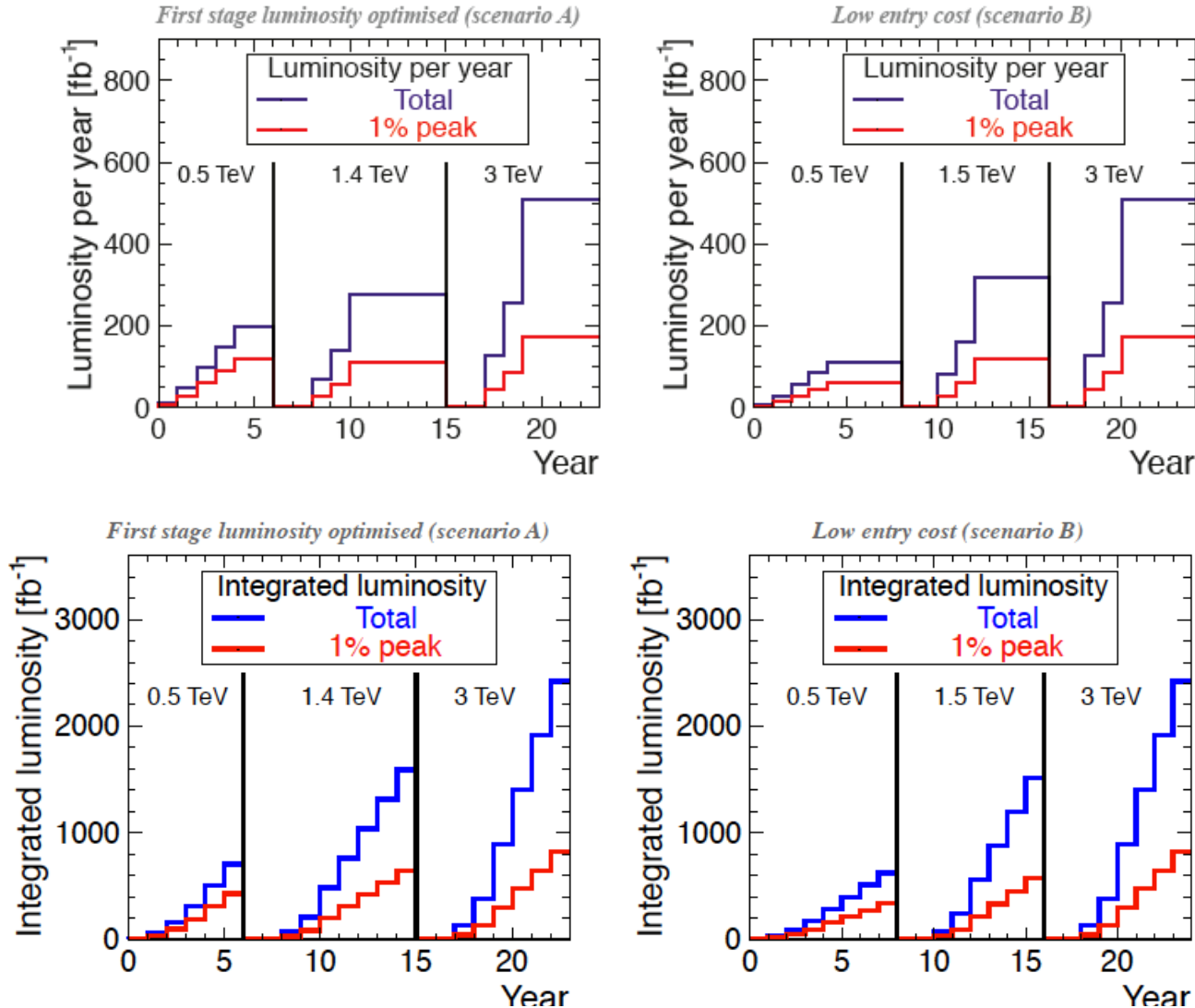

Based on 200 days/year at 50% efficiency (accelerator + data taking combined)

Target figures:
>600 fb⁻¹ at first stage, 1.5 ab⁻¹ at second stage, 2 ab⁻¹ at third stage

Fig. 5.2: Integrated luminosity in the scenarios optimised for luminosity in the first energy stage (left) and optimised for entry costs (right). Years are counted from the start of beam commissioning. These figures include luminosity ramp-up of four years (5%, 25%, 50%, 75%) in the first stage and two years (25%, 50%) in subsequent stages.

Z' Sensitivity Study

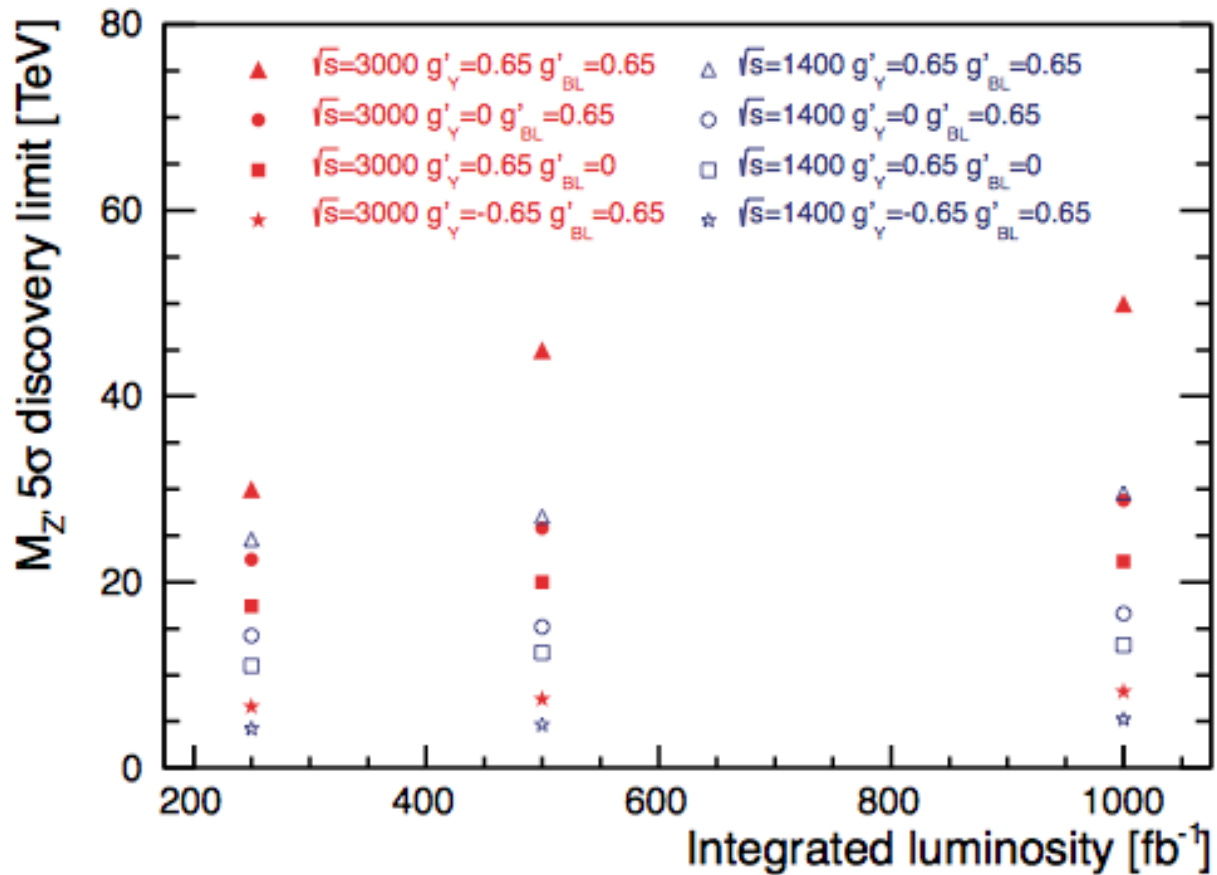

CLIC_ILD ↙ and CLIC_SiD ↘ tracker



TPC + silicon tracker in 4 Tesla field

all-silicon tracker in 5 Tesla field

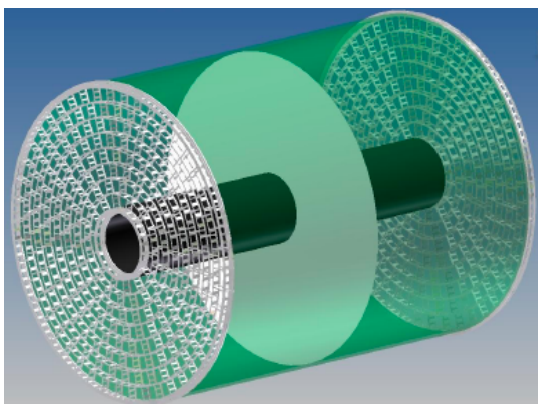
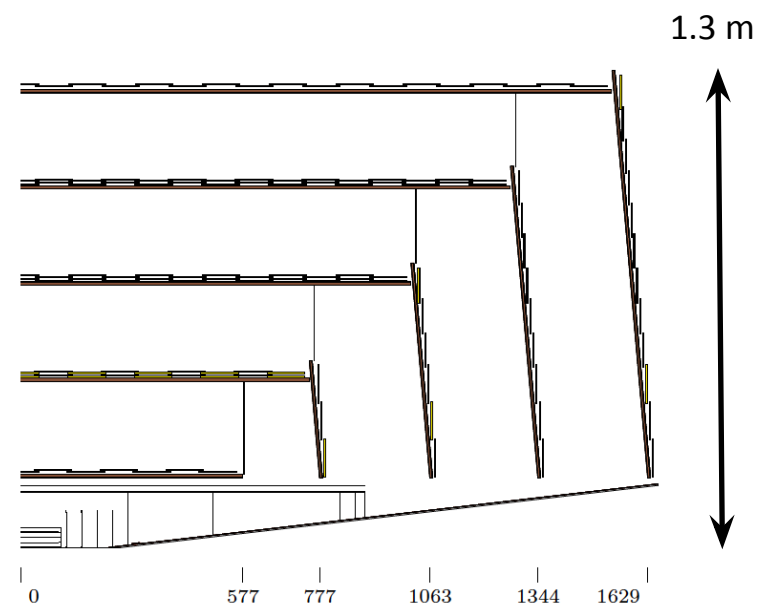
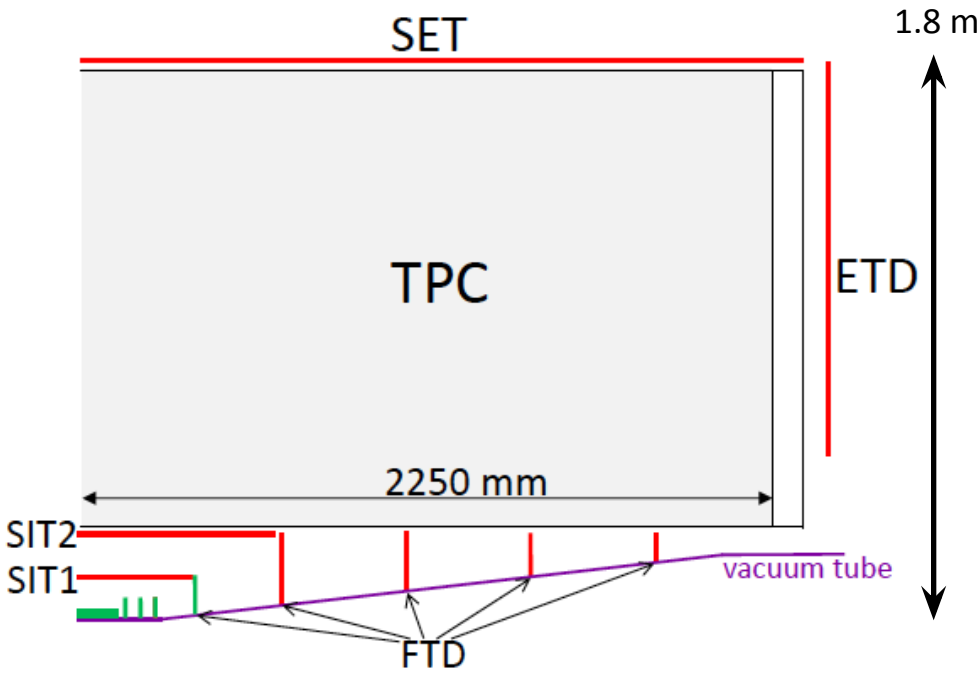

Time Projection Chamber (TPC) with MPGD readout

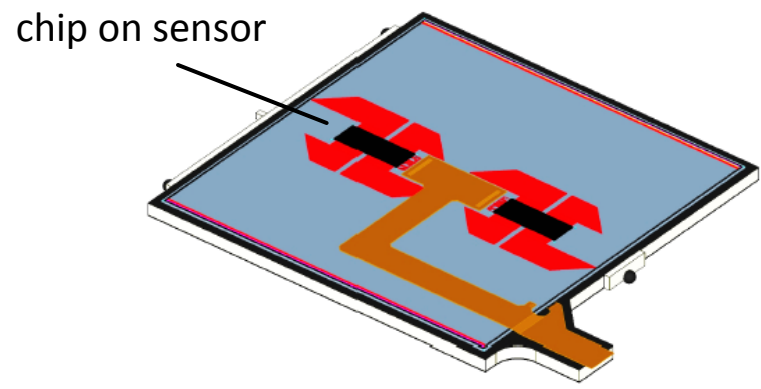

PFA calorimetry at CLIC



ECAL

Si or Scint. (active) + Tungsten (absorber)
cell sizes 13 mm² or 25 mm²
30 layers in depth

HCAL

Several technology options: **scint. or gas Tungsten (barrel)**, steel (endcap)
cell sizes 9 cm² (analog) or 1 cm² (digital)
60-75 layers in depth
Total depth $7.5 \Lambda_i$

← technology

simulated
jet energy resolution

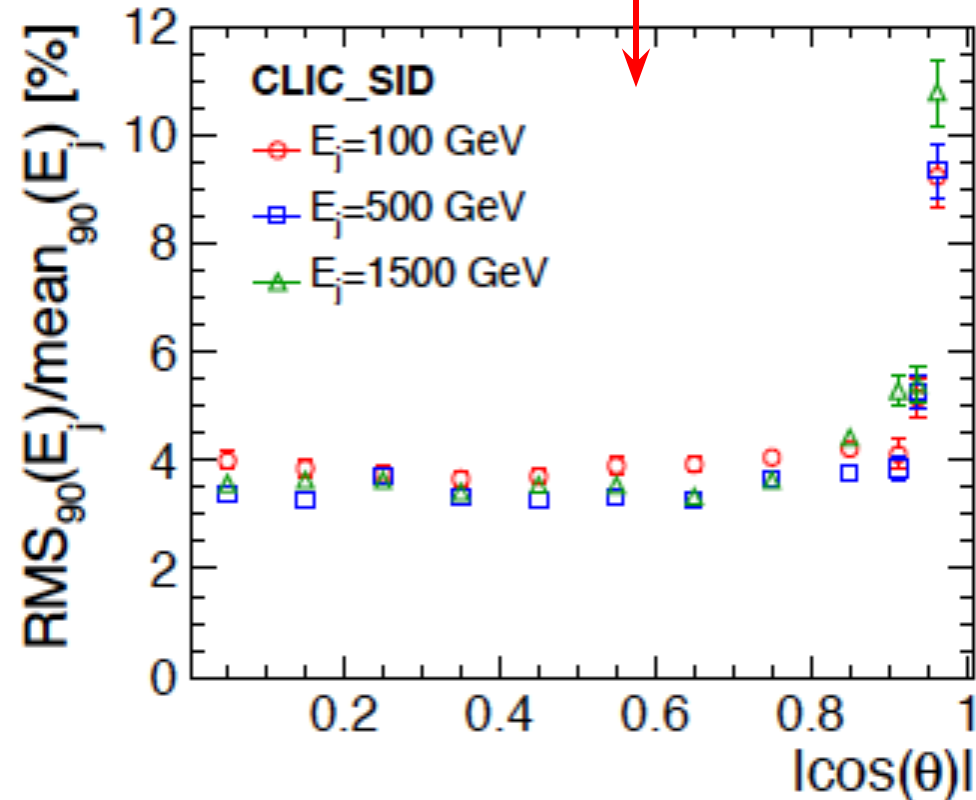
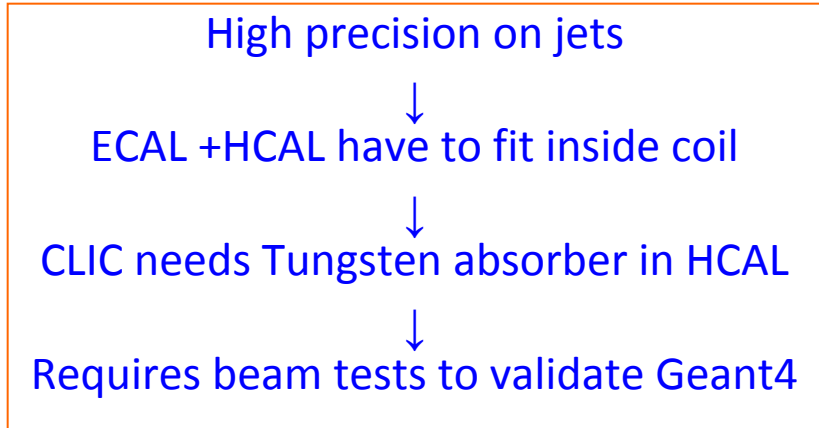

(no jet clustering, without background overlay)

Higgs Summary

Higgs studies for $m_H = 120$ GeV

\sqrt{s} (GeV)	Process	Decay mode	Measured quantity	Unit	Generator value	Stat. error	Comment
350		$ZH \rightarrow \mu^+\mu^-X$	σ	fb	4.9	4.9%	Model
			Mass	GeV	120	0.131	independent, using Z -recoil
500	SM Higgs production	$ZH \rightarrow q\bar{q}q\bar{q}$	$\sigma \times \text{BR}$	fb	34.4	1.6%	$ZH \rightarrow q\bar{q}q\bar{q}$
			Mass	GeV	120	0.100	mass reconstruction
500		$ZH, H\nu\bar{\nu} \rightarrow \nu\bar{\nu}q\bar{q}$	$\sigma \times \text{BR}$	fb	80.7	1.0%	Inclusive
			Mass	GeV	120	0.100	sample
1400		$H \rightarrow \tau^+\tau^-$			19.8	<3.7%	
3000	WW fusion	$H \rightarrow b\bar{b}$	$\sigma \times \text{BR}$	fb	285	0.22%	
		$H \rightarrow c\bar{c}$			13	3.2%	
		$H \rightarrow \mu^+\mu^-$			0.12	15.7%	
1400	WW fusion		Higgs tri-linear coupling			~20%	
3000			g_{HHH}			~20%	

SUSY Summary

\sqrt{s} (TeV)	Process	Decay mode	SUSY model	Measured quantity	Unit	Gene- rator value	Stat. error
1.4	Sleptons production	$\tilde{\mu}_R^+ \tilde{\mu}_R^- \rightarrow \mu^+ \mu^- \tilde{\chi}_1^0 \tilde{\chi}_1^0$	III	σ	fb	1.11	2.7%
				\tilde{l} mass	GeV	560.8	0.1%
				$\tilde{\chi}_1^0$ mass	GeV	357.8	0.1%
		$\tilde{e}_R^+ \tilde{e}_R^- \rightarrow e^+ e^- \tilde{\chi}_1^0 \tilde{\chi}_1^0$		σ	fb	5.7	1.1%
				\tilde{l} mass	GeV	558.1	0.1%
				$\tilde{\chi}_1^0$ mass	GeV	357.1	0.1%
		$\tilde{\nu}_e \tilde{\nu}_e \rightarrow \tilde{\chi}_1^0 \tilde{\chi}_1^0 e^+ e^- W^+ W^-$		σ	fb	5.6	3.6%
				\tilde{l} mass	GeV	644.3	2.5%
				$\tilde{\chi}_1^\pm$ mass	GeV	487.6	2.7%
1.4	Stau production	$\tilde{\tau}_1^+ \tilde{\tau}_1^- \rightarrow \tau^+ \tau^- \tilde{\chi}_1^0 \tilde{\chi}_1^0$	III	$\tilde{\tau}_1$ mass	GeV	517	2.0%
				σ	fb	2.4	7.5%
1.4	Chargino production	$\tilde{\chi}_1^+ \tilde{\chi}_1^- \rightarrow \tilde{\chi}_1^0 \tilde{\chi}_1^0 W^+ W^-$	III	$\tilde{\chi}_1^\pm$ mass	GeV	487	0.2%
				σ	fb	15.3	1.3%
1.4	Neutralino production	$\tilde{\chi}_2^0 \tilde{\chi}_2^0 \rightarrow h/Z^0 h/Z^0 \tilde{\chi}_1^0 \tilde{\chi}_1^0$	III	$\tilde{\chi}_2^0$ mass	GeV	487	0.1%
				σ	fb	5.4	1.2%

Results of detailed simulation study for a given SUSY model (model III)

CLIC operated at 1.4 TeV, 1.5 ab^{-1}

Results from earlier stage(s) not taken into account

Susy models I & II

\sqrt{s} (TeV)	Process	Decay mode	SUSY model	Measured quantity	Unit	Gene- rator value	Stat. error	
3.0	Sleptons production	$\tilde{\mu}_R^+ \tilde{\mu}_R^- \rightarrow \mu^+ \mu^- \tilde{\chi}_1^0 \tilde{\chi}_1^0$	II	σ	fb	0.72	2.8%	
				$\tilde{\ell}$ mass	GeV	1010.8	0.6%	
				$\tilde{\chi}_1^0$ mass	GeV	340.3	1.9%	
		$\tilde{e}_R^+ \tilde{e}_R^- \rightarrow e^+ e^- \tilde{\chi}_1^0 \tilde{\chi}_1^0$		σ	fb	6.05	0.8%	
				$\tilde{\ell}$ mass	GeV	1010.8	0.3%	
				$\tilde{\chi}_1^0$ mass	GeV	340.3	1.0%	
		$\tilde{e}_L^+ \tilde{e}_L^- \rightarrow \tilde{\chi}_1^0 \tilde{\chi}_1^0 e^+ e^- hh$ $\tilde{e}_L^+ \tilde{e}_L^- \rightarrow \tilde{\chi}_1^0 \tilde{\chi}_1^0 e^+ e^- Z^0 Z^0$		σ	fb	3.07	7.2%	
				$\tilde{\nu}_e \tilde{\nu}_e \rightarrow \tilde{\chi}_1^0 \tilde{\chi}_1^0 e^+ e^- W^+ W^-$	σ	fb	13.74	2.4%
					$\tilde{\ell}$ mass	GeV	1097.2	0.4%
		$\tilde{\chi}_1^\pm$ mass			GeV	643.2	0.6%	
3.0	Chargino production	$\tilde{\chi}_1^+ \tilde{\chi}_1^- \rightarrow \tilde{\chi}_1^0 \tilde{\chi}_1^0 W^+ W^-$	II	$\tilde{\chi}_1^\pm$ mass	GeV	643.2	1.1%	
	Neutralino production	$\tilde{\chi}_2^0 \tilde{\chi}_2^0 \rightarrow h/Z^0 h/Z^0 \tilde{\chi}_1^0 \tilde{\chi}_1^0$		σ	fb	10.6	2.4%	
3.0	Production of right-handed squarks	$\tilde{q}_R \tilde{q}_R \rightarrow q \bar{q} \tilde{\chi}_1^0 \tilde{\chi}_1^0$	I	$\tilde{\chi}_2^0$ mass	GeV	643.1	1.5%	
				σ	fb	3.3	3.2%	
3.0	Heavy Higgs production	$H^0 A^0 \rightarrow b \bar{b} b \bar{b}$ $H^+ H^- \rightarrow t \bar{b} b \bar{t}$	I	Mass	GeV	1123.7	0.52%	
				σ	fb	1.47	4.6%	
3.0	Heavy Higgs production	$H^0 A^0 \rightarrow b \bar{b} b \bar{b}$ $H^+ H^- \rightarrow t \bar{b} b \bar{t}$	I	Width	GeV	902.4	0.3%	
				Width	GeV	906.3	31%	
3.0	Heavy Higgs production	$H^0 A^0 \rightarrow b \bar{b} b \bar{b}$ $H^+ H^- \rightarrow t \bar{b} b \bar{t}$	I	Mass	GeV	906.3	0.3%	
				Width	GeV	906.3	27%	

PFA Performance w/o background

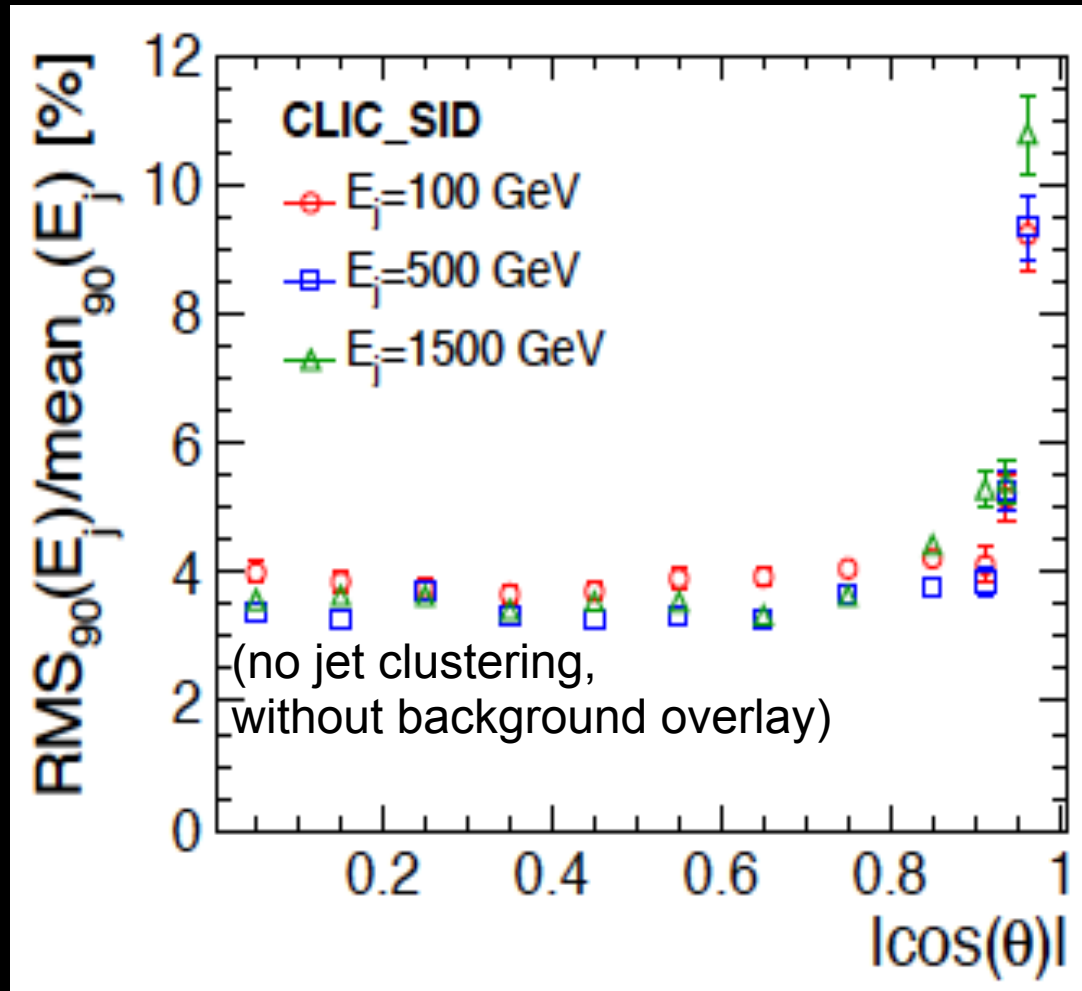

Detector Costing (no labor)

Table 5.4: Value estimate of the CLIC detectors.

	CLIC_ILD (MCHF)	CLIC_SiD (MCHF)
Vertex	13	15
Tracker	51	17
Electromagnetic calorimeter	197	89
Hadronic calorimeter	144	86
Muon system	28	22
Coil and yoke	117	123
Other	11	12
Total (rounded)	560	360

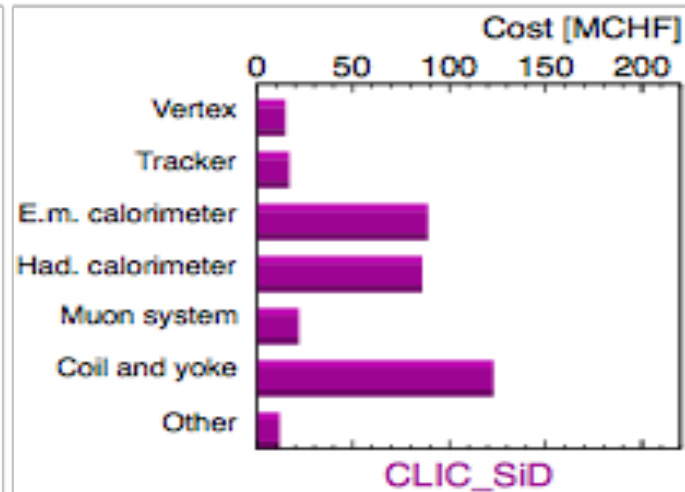
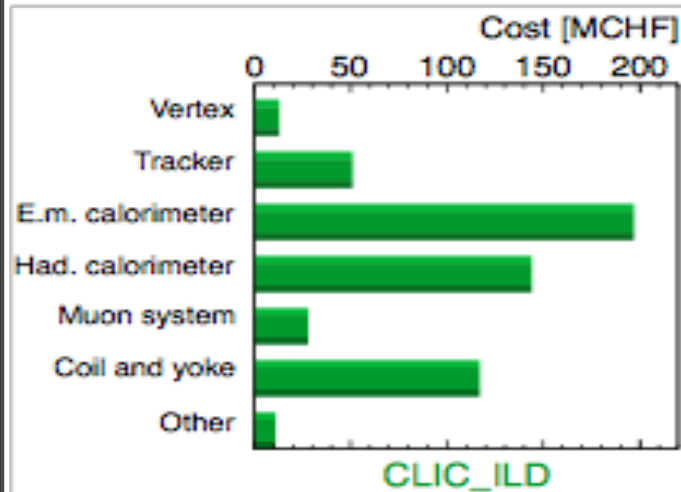

Fig. 5.9: Cost structure of the CLIC detectors.

Vertex Region Layout

	CLIC_ILD	CLIC_SiD
Central beam pipe	Beryllium $R_i = 29.4 \text{ mm}$ $d = 0.6 \text{ mm}$	Beryllium $R_i = 24.5 \text{ mm}$ $d = 0.5 \text{ mm}$
Barrel region	3 double layers $ z < 130 \text{ mm}$ $R_i = 31, 44, 58 \text{ mm}$	5 single layers $ z < 98.5 \text{ mm}$ $R_i = 27, 38, 51, 64, 77 \text{ mm}$
Forward region	3 double layers $z = 160, 207, 255 \text{ mm}$	7 single layers $z = 120, 160, 200, 240, 280, 500, 830 \text{ mm}$
Sensors	$20 \mu\text{m} \times 20 \mu\text{m}$, $\sigma_{fp} \approx 3 \mu\text{m}$ $X/X_0 = 0.18\%$ per double layer	$20 \mu\text{m} \times 20 \mu\text{m}$, $\sigma_{fp} \approx 3 \mu\text{m}$ $X/X_0 = 0.11\%$ per single layer
Surface area	0.736 m^2	1.103 m^2
Number of channels	1.84×10^9	2.76×10^9



The Silicon Envelope in numbers (current scheme)

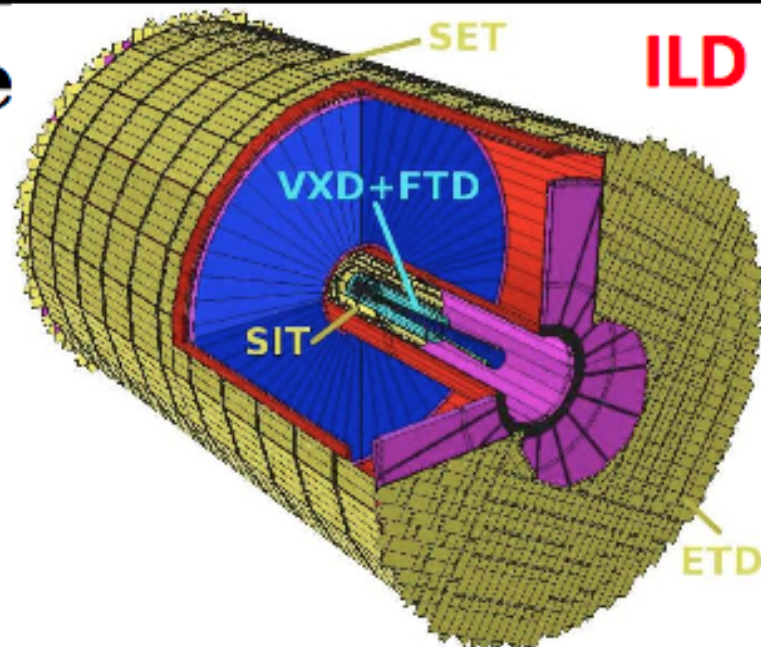

Component	Layer #	# modules	# sensors/ module	# channels	Total surface m ²
SIT1	1 st layer	33	3	66.000	0.9
	2 nd layer	99	1	198.000	0.9
SIT2	1 st layer	90	3	180.000	2.7
	2 nd layer	270	1	540.000	2.7
SET	1 st layer	1260	5	2.520.000	55.2
	2 nd layer	1260	5	2.520.000	55.2
ETD_F	X or U or V	82/quad =328/layer =984/ETD	2 or 3 or possibly 4	2.000.000	30
ETD_B	idem	idem	idem	idem	30

Total number of channels:
 10^6 (SIT) + 5×10^6 (SET) + 4×10^6 (2 ETD)
= 10×10^6 channels

Total area:
 7 (SIT) + 110 (SET) + 2x30 (ETDs) = **180 m²**

Total number of modules:
 500 (SIT) + 2500 (SET) + 2000 (ETDs) =
5000 modules with unique size sensors
**=> Achieved: a unified and simple design
 for all components (except FTD)**

Taken from: Aurore Savoy-Navarro, talk for
 Terceras Jornadas sobre la Participación Española en los Futuros
 Aceleradores Lineales de Partículas - 7 a 8 Mayo, Barcelona

Key Parameters of the CLIC machine

Parameter	Symbol	Unit	500 GeV	3 TeV
Centre-of-mass energy	\sqrt{s}	TeV	0.5	3.0
Repetition frequency	f_{rep}	Hz	50	50
Number of bunches per train	n_b		354	312
Bunch separation	Δt	ns	0.5	0.5
Accelerating gradient	G	MV/m	80	100
Total luminosity	\mathcal{L}_{total}	$10^{36} \text{cm}^{-2} \text{s}^{-1}$	2.3	5.9
Luminosity above 99% of \sqrt{s}	$\mathcal{L}_{0.99}$	$10^{34} \text{cm}^{-2} \text{s}^{-1}$	1.4	2.0
Number of photons per electron/positron	n_γ		1.3	2.1
Average energy loss due to beamstrahlung	$\Delta E/E$		0.07	0.28
Number of coherent pairs per bunch crossing	N_{coh}		2×10^{-2}	6.8×10^8
Energy of coherent pairs per bunch crossing	E_{coh}	TeV	15	2.1×10^8
Number of incoherent pairs per bunch crossing	n_{incoh}	10^6	0.08	0.3
Energy of incoherent pairs per bunch crossing	E_{incoh}	10^6 GeV	0.36	23
Hadronic events per bunch crossing	n_{had}		0.3	3.2

Background Properties

