

Longbase Neutrino Physics

Neil McCauley

University of Liverpool

Birmingham February 2013



UNIVERSITY OF
LIVERPOOL

Neutrino mixing

- Neutrino mixing is characterised by the PMNS matrix.

$$\mathbf{U}_{PMNS} = \begin{pmatrix} \cos\theta_{12} & \sin\theta_{12} & 0 \\ -\sin\theta_{12} & \cos\theta_{12} & 0 \\ 0 & 0 & 1 \end{pmatrix} \begin{pmatrix} \cos\theta_{13} & 0 & \sin\theta_{13}e^{-i\delta} \\ 0 & 1 & 0 \\ -\sin\theta_{13}e^{i\delta} & 0 & \cos\theta_{13} \end{pmatrix} \begin{pmatrix} 1 & 0 & 0 \\ 0 & \cos\theta_{23} & \sin\theta_{23} \\ 0 & -\sin\theta_{23} & \cos\theta_{23} \end{pmatrix}$$

- Fundamental parameters of nature just like CKM
- Open questions for long baseline experiments:

- Mass Hierarchy.
 - Either/or question.
 - Appears through matter effect.
- CP Violating Phase δ
- Mixing Angles θ_{13}, θ_{23} .
 - Octant of θ_{23}
 - Is θ_{23} maximal?

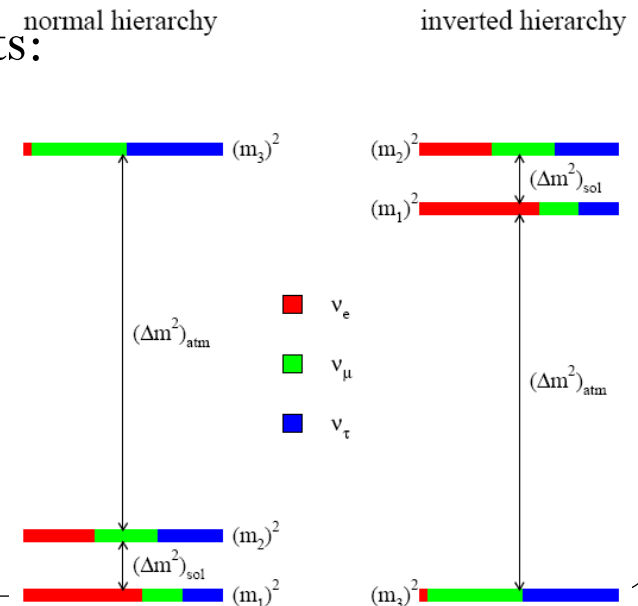

Oscillations and measurement

- Different oscillation channels are sensitive to different combinations of mixing parameters
 - In general we want to measure $P_{\text{osc}}(E_\nu)$
- Short Baseline Reactors: $p \sim \sin^2 2\theta_{13}, \Delta m^2_{13}$
 - Directly measure θ_{13} .
 - Solar term at longer baselines.
- Long Baseline: $p \sim \sin^2 \theta_{23} \sin^2 2\theta_{13}, \Delta m^2_{13}$
 - Combination of mixing angles
 - Octant important.
- Corrections
 - Matter Term \rightarrow sign of Δm^2_{13} , mass hierarchy.
 - CP Terms \rightarrow CP Even and CP odd terms \rightarrow CPV
 - Solar Term.

Current Status

- Current programs first aim : θ_{13}
 - Gatekeeper to CP Violation and Mass Hierarchy
 - Knowledge of θ_{13} required to plan next stages of neutrino program.
 - Discovery of non-zero θ_{13} key development of the last 12 months.
- Also aim to
 - Reduce uncertainties on other oscillation parameters
 - Start to test the 3 neutrino oscillation model

Reactor Experiments

- Search for θ_{13} short baseline, disappearance mode.
 - $p(\nu_e \rightarrow \nu_e)$
- Clean measurement of θ_{13} , independent of other mixing parameters
 - Does require Δm^2 from long baseline experiments.

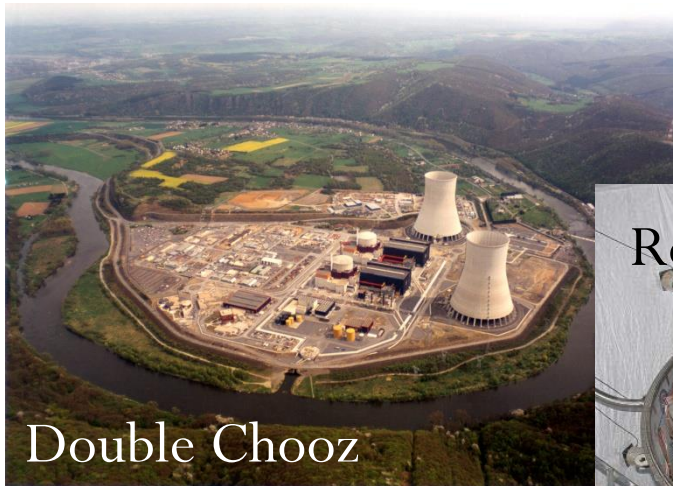
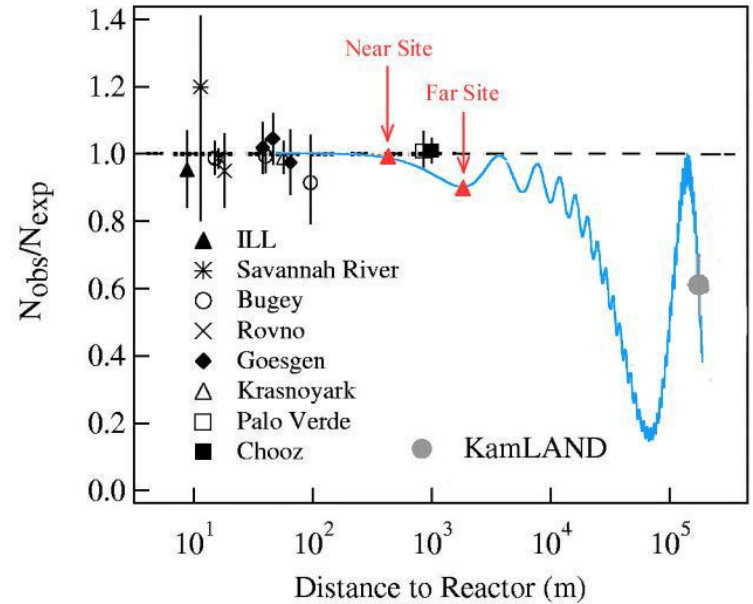

Double Chooz

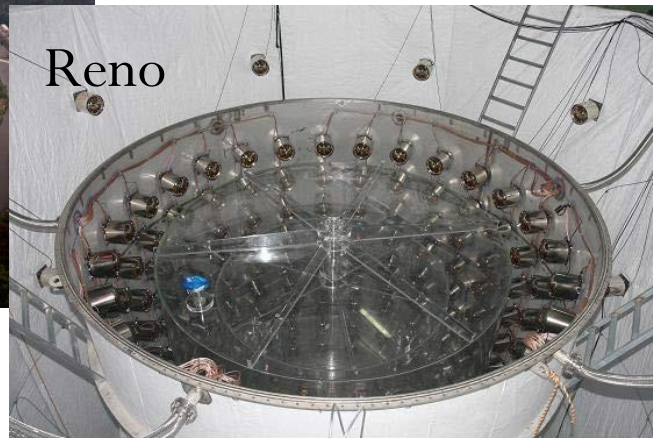

Reno

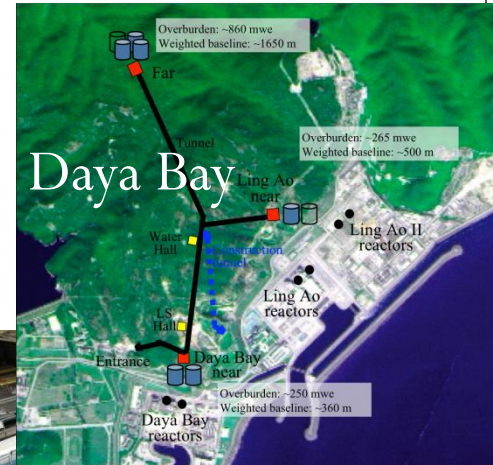
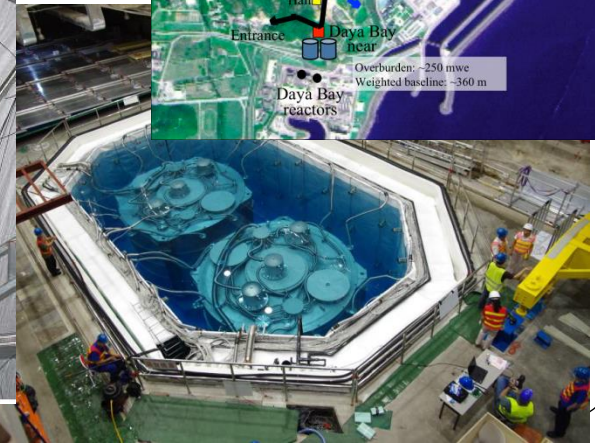

Results from Reactors

- Measurement of non-zero θ_{13}
 - Daya Bay : $\text{Sin}^2 2\theta_{13} = 0.089 \pm 0.010(\text{stat}) \pm 0.005(\text{syst}) 7.7\sigma$
 - Reno : $\text{Sin}^2 2\theta_{13} = 0.113 \pm 0.013(\text{stat}) \pm 0.019(\text{syst}) 4.9\sigma$

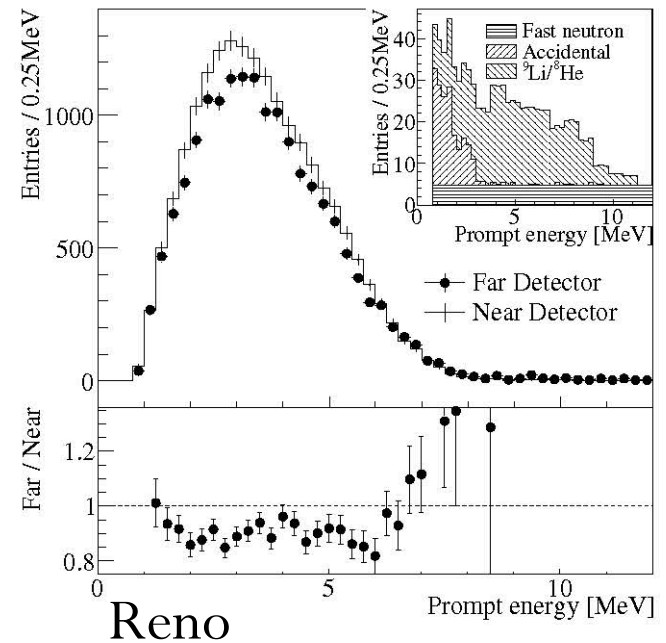
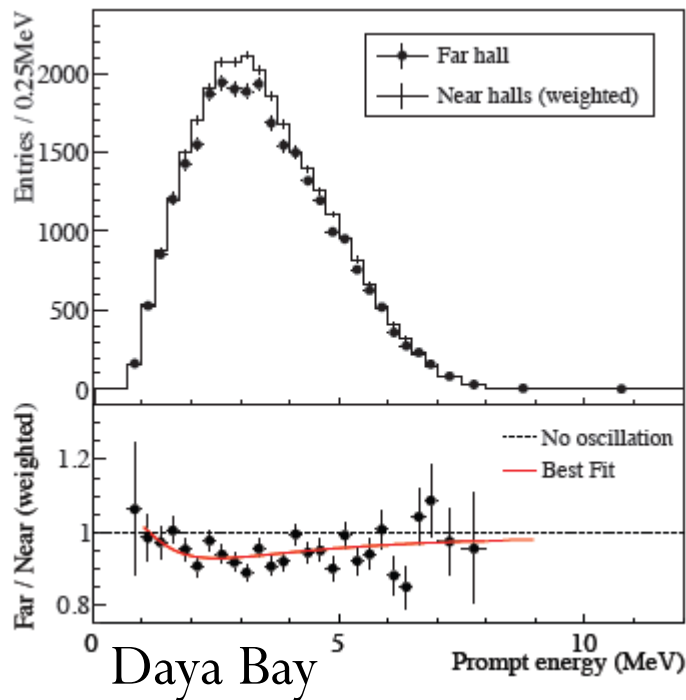

T2K Experiment

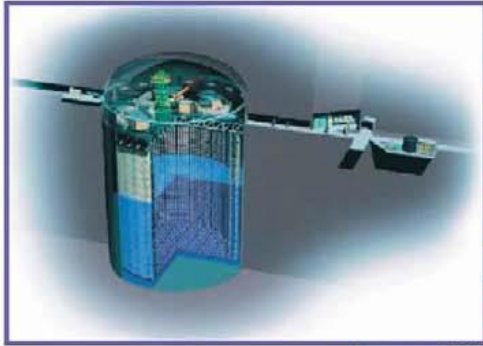

Super-Kamiokande
(ICRR, Univ. Tokyo)



J-PARC Main Ring
(KEK-JAEA, Tokai)



- 295km baseline
- Narrow band neutrino beam $E_{peak} \sim 600 \text{ MeV}$
- First measurements using off-axis beam technique.

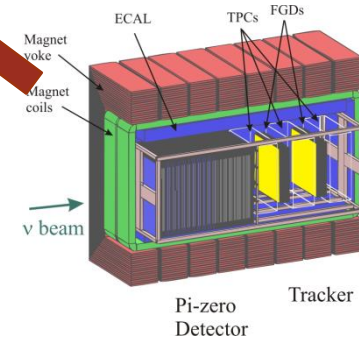

T2K Data

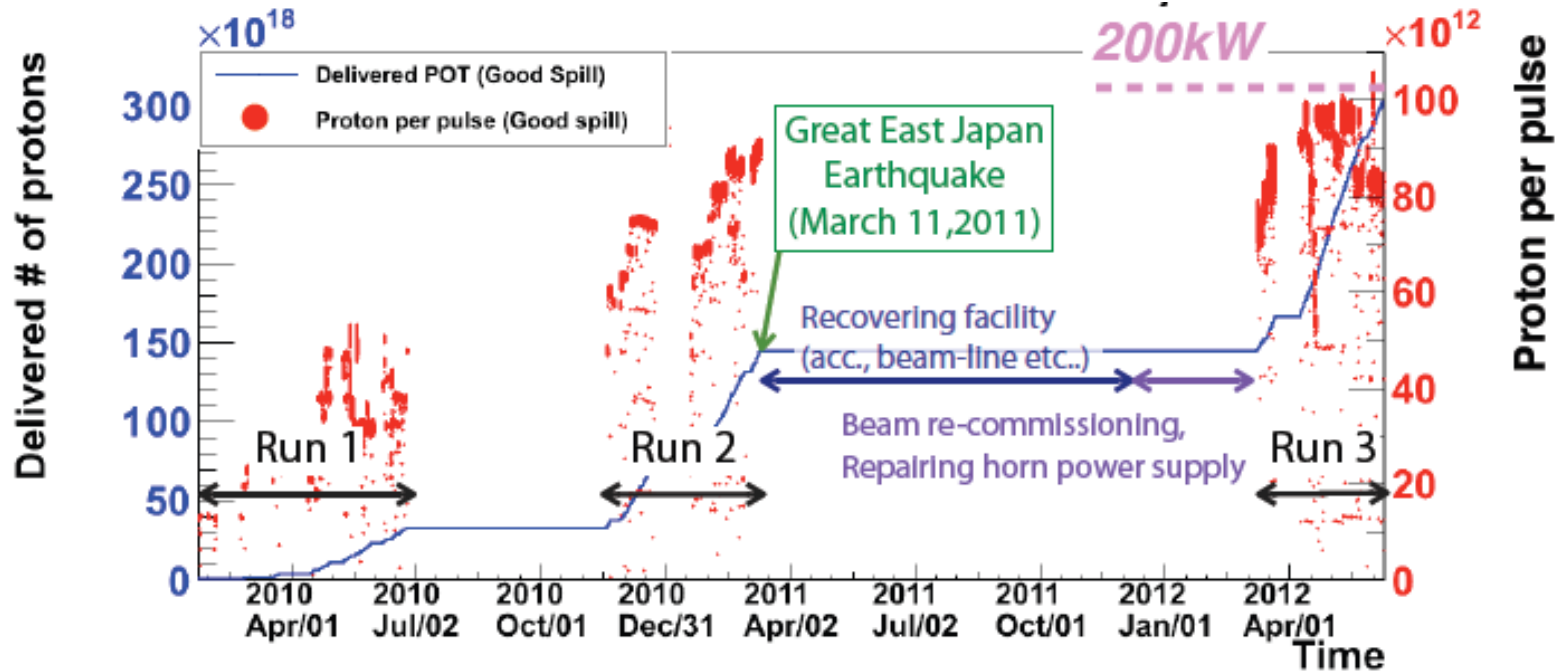

Run1 + 2 (2010-2011)
 1.43×10^{20} p.o.t.

* ND280 Run1+2 data is used for oscillation analysis

Run3 (2012) : 1.58×10^{20} p.o.t

* including 0.21×10^{20} p.o.t. with 200kA horn operation (13% flux reduction at peak) (250kA horn current for nominal operation)

* ND280 Run3 data is checked and consistent with Run1+2

- T2K now running again and fully operational following the March 2011 earthquake.

T2K Flux

- Flux prediction from beam group
 - Includes hadron production constraints from NA61
- ν_μ interactions measured at ND280
 - Fit to reduce flux uncertainties and cross section constraints.

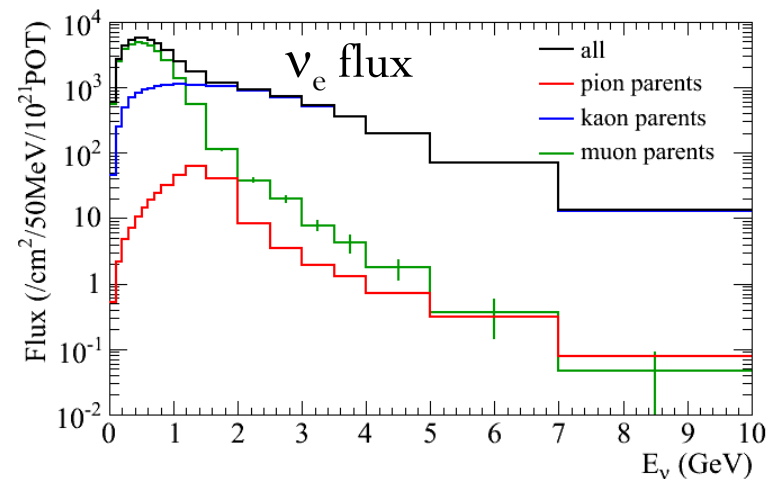
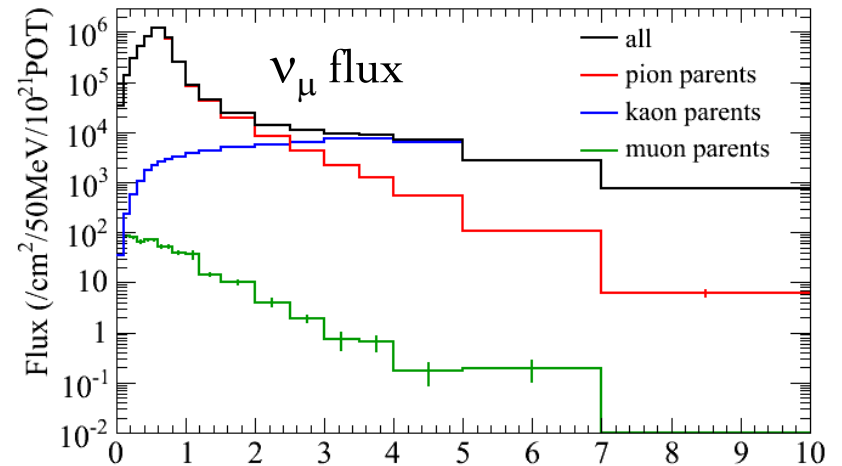
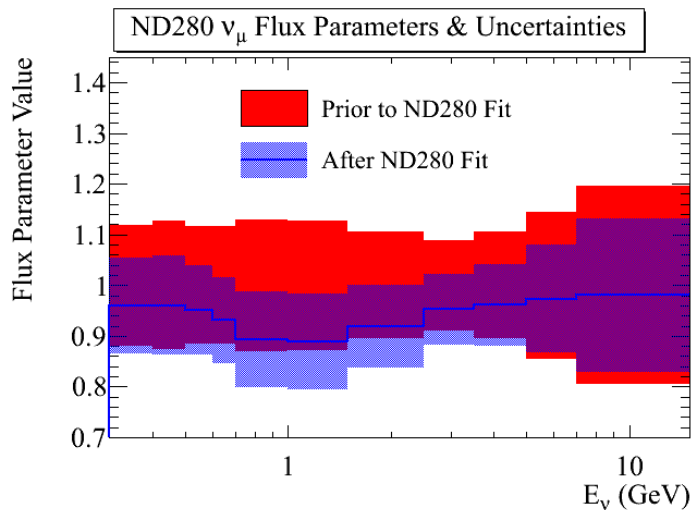

Detection of $\nu_{\mu} \rightarrow \nu_e$

- 11 events observed, 2.94 background expected
- Detection of θ_{13} at 3.2σ .
- $\sin^2 2\theta_{13} = 0.094^{+0.053}_{-0.040}$
- Normal Hierarchy, $\delta=0$

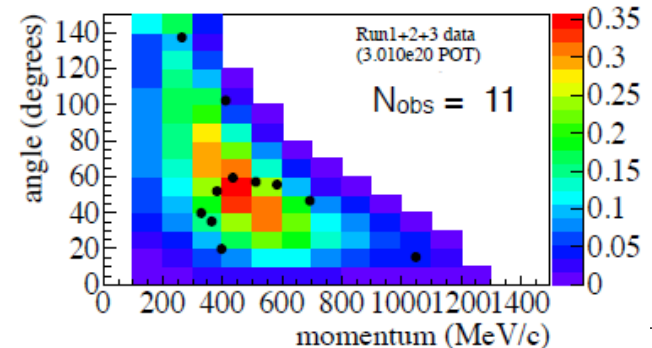
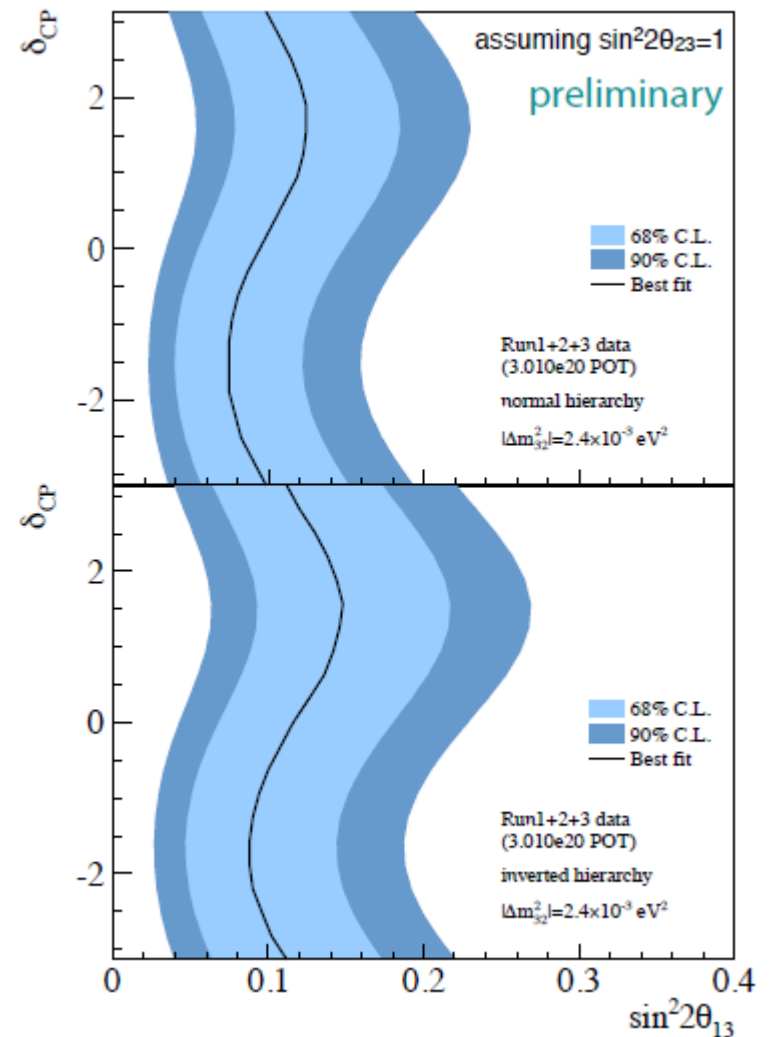
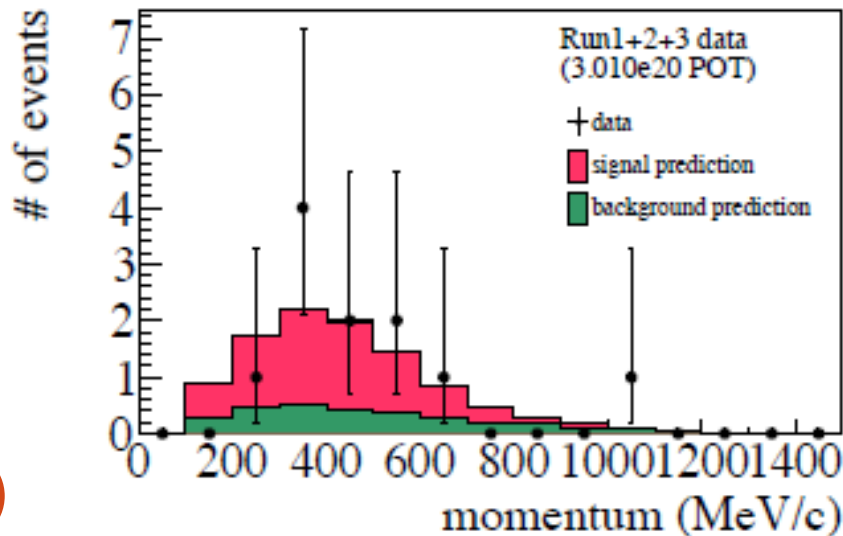

Minos

- 735 km baseline
- Uses NUMI beam in low energy configuration
 - Full dataset now collected.
- 5.4 kton magnetised iron calorimeter
 - 980 ton near detector

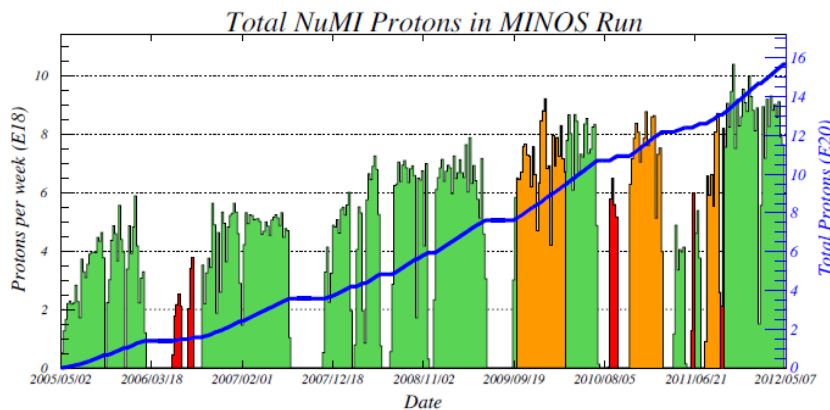

Low Energy
Neutrino Beam

Low Energy
Antineutrino Beam

Special Running

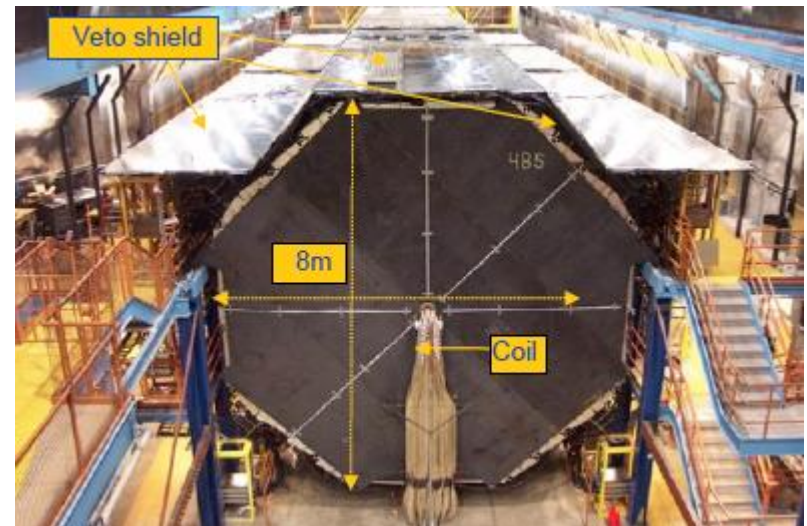

Measurements of θ_{23}

- Atmospheric neutrino results still very competitive.
- Crucial to improve measurement of θ_{23} as it appears with θ_{13} in long baseline probabilities.

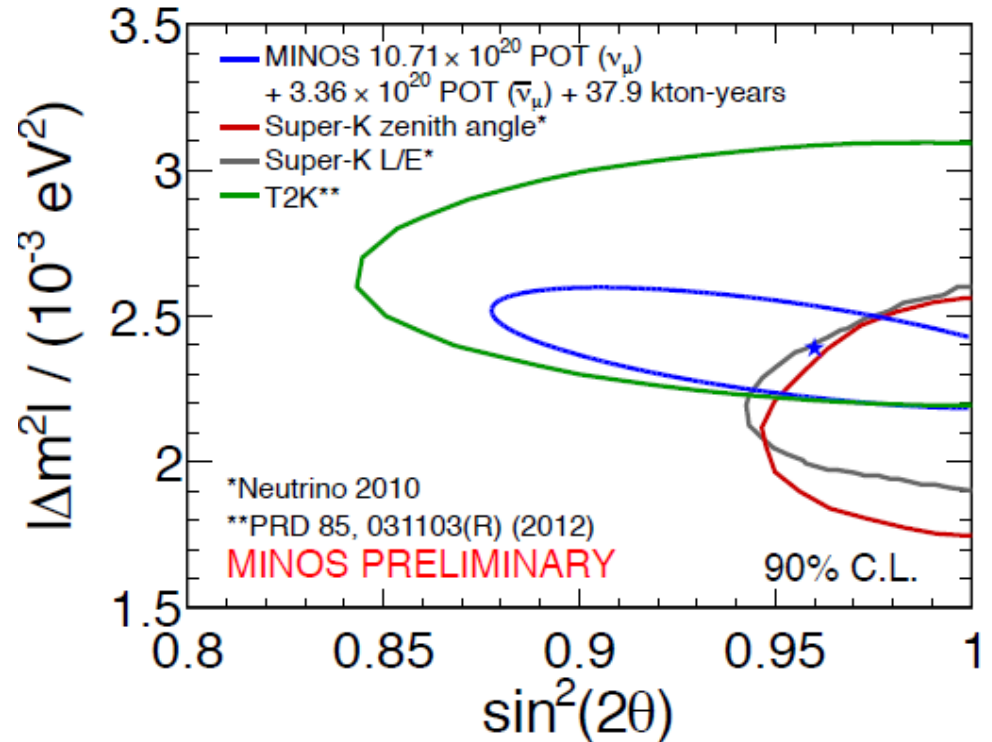
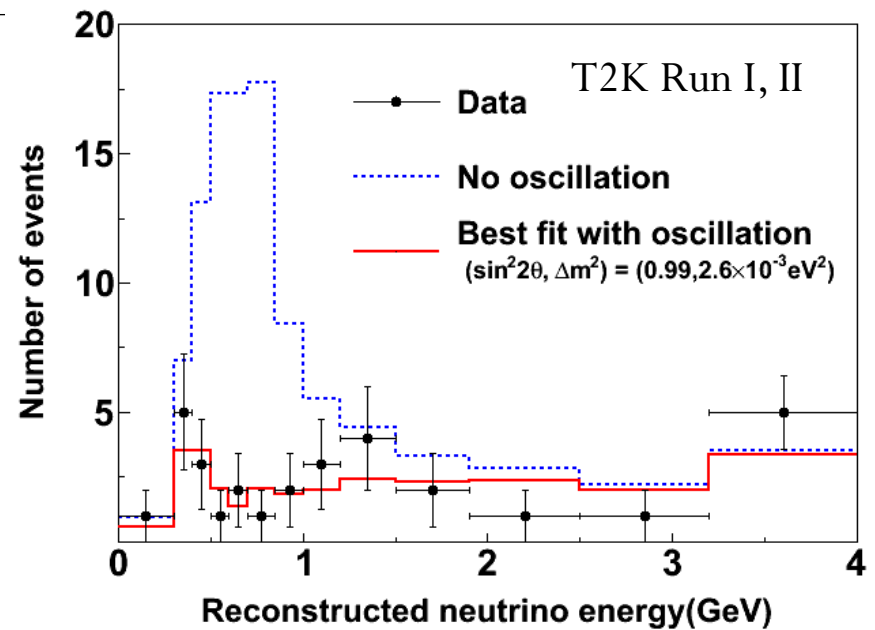
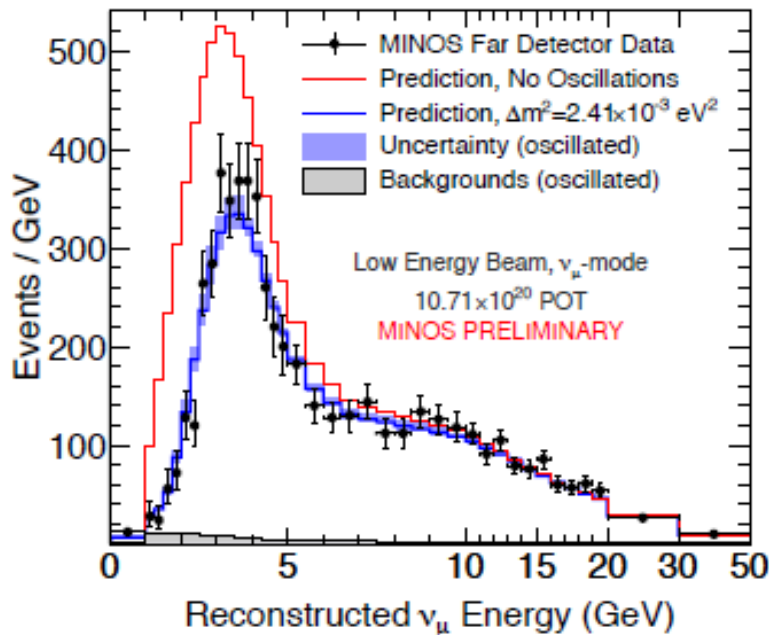

Long baseline experiments to ~2020

- For the next decade the neutrino community will be working to fully exploit existing neutrino beamlines:
 - JPARC-SK
 - NUMI
 - CNGS
- Improved measurements of θ_{13} , θ_{23} and Δm^2 .
 - Requires reduction in systematics with better cross section measurements.
- Potential sensitivity to CP violation in some scenarios.

T2K Programme

- Plan to continue increasing beam power over the next 10 years.
 - Aim for 750kW by 2018
 - 400 MeV Linac upgrade in 2013 long shutdown (July-Dec).
 - Final target dataset $750\text{kW} \times 5 \times 10^7 \text{s}$.
 - Current data $\sim 5\%$ of this.
- Significant reduction in error bars for θ_{13} , θ_{23} and Δm^2_{23}
- Program of cross section measurements with near detector.

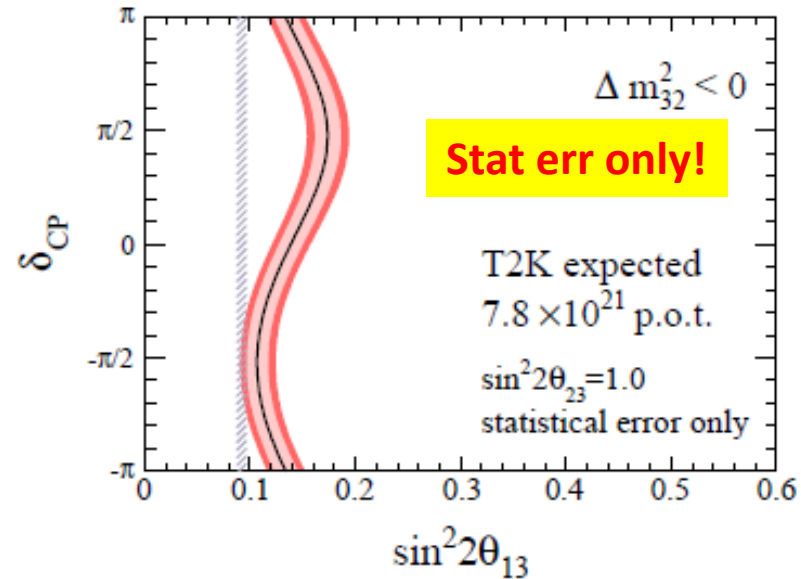

Expected
beam power

May 2012	2014	2018
190kW	300kW	750kW

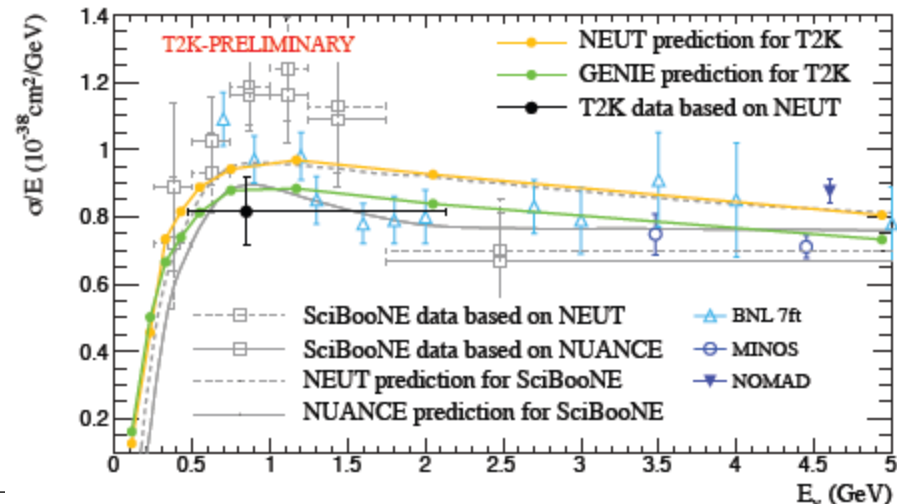

NO ν A

- Continued exploitation of the NUMI beamline.
- 14 kt totally active scintillator detector.
 - On surface.
 - Ash River Mn
- Baseline 810km
 - 14mrad off axis
- Beam power 350 kW \rightarrow \sim 700kW

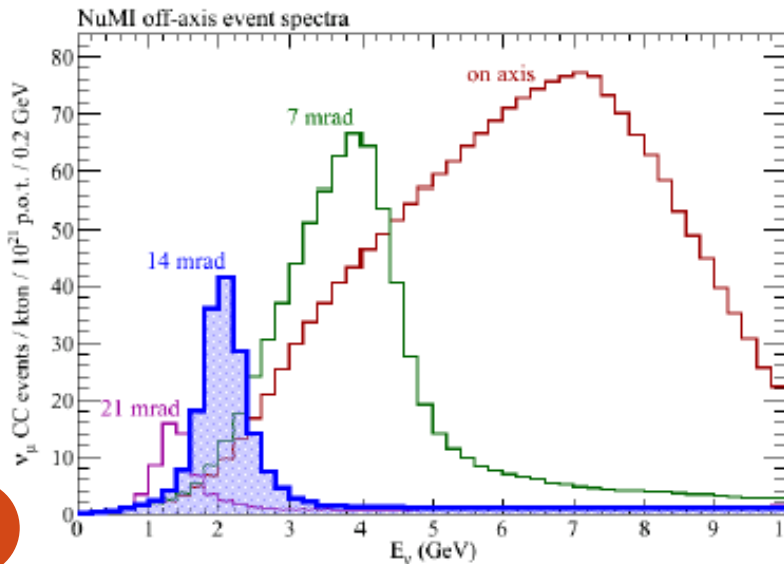
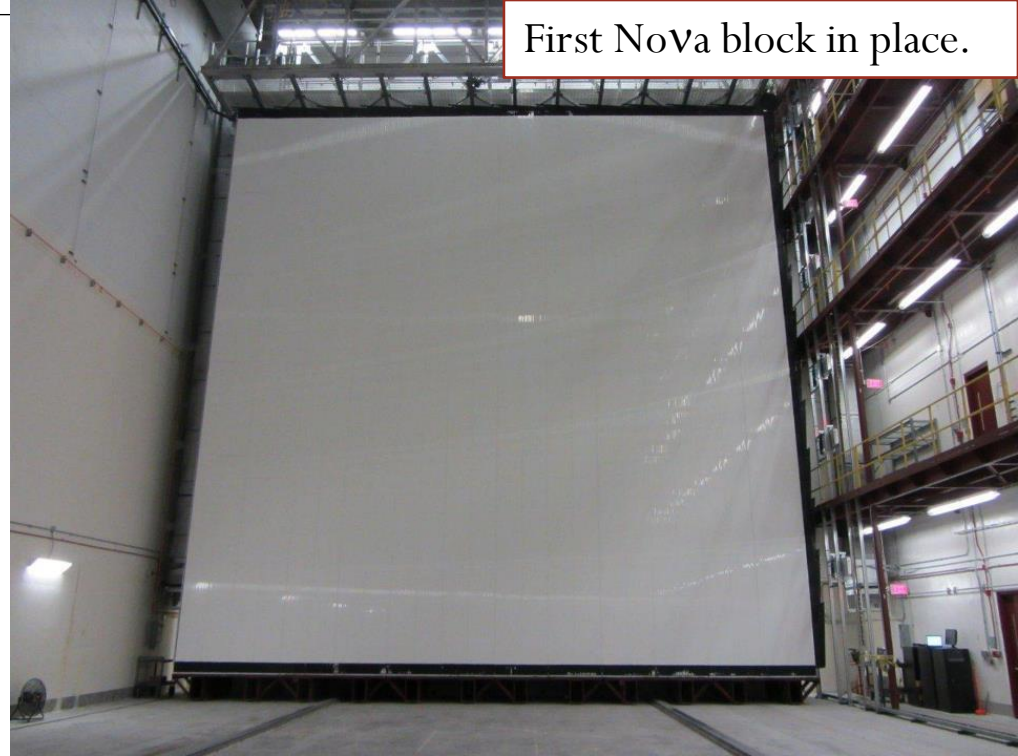

NOvA physics reach

- Assume 3 yr ν / 3 yr anti ν .
- Potential for 5σ ν_e appearance in first year
- Investigate mass hierarchy, CPV and θ_{23} including octant in course of run.

1 and 2 σ Contours for Starred Point

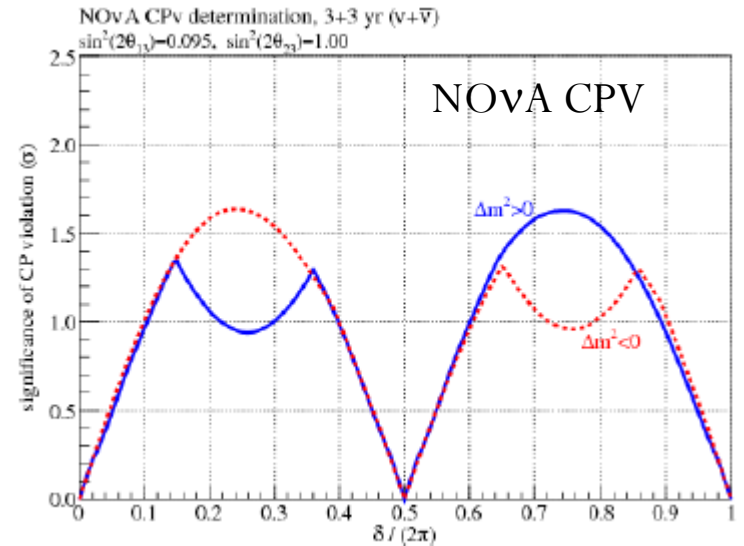
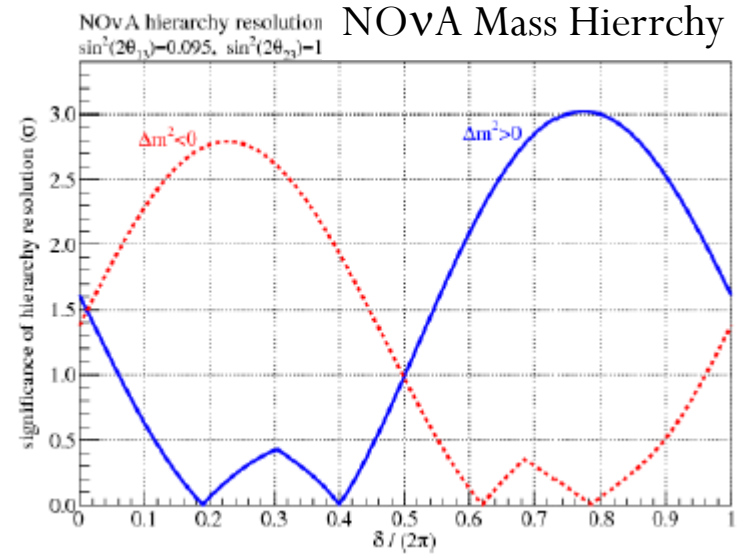
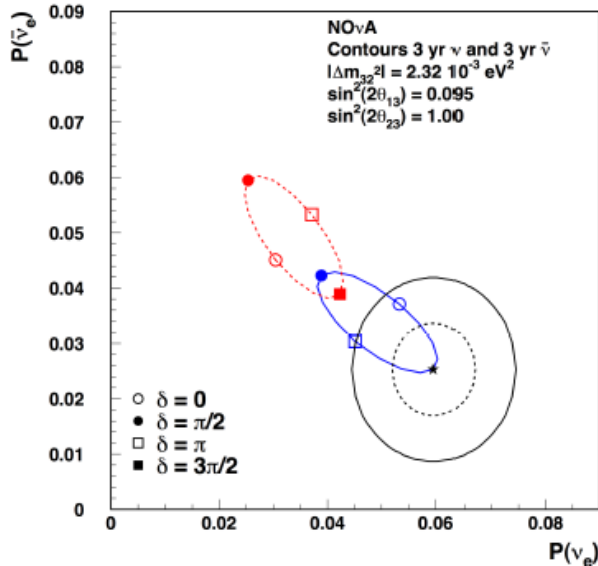

Combining Results

- In many ways T2K and NOvA complement each other.
 - Different matter effects
 - Can help resolve ambiguities in the parameters and improve sensitivity to mass hierarchy and CPV.
 - Reactor experiments also contribute.
- Health warning:
 - Global fits be necessity assume the 3 neutrino mixing model.

Potential error on δ
From ArXiv: 1203.5651

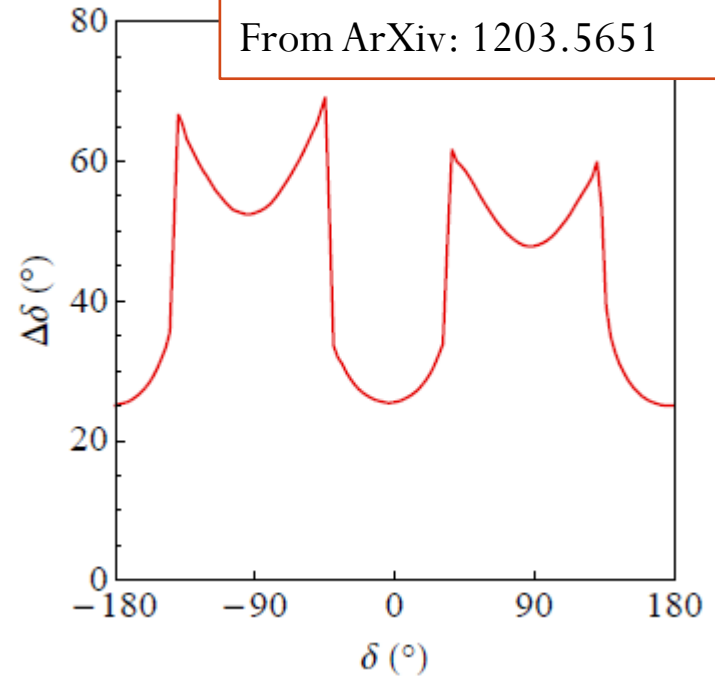

Mass Hierarchy Discovery (3σ)
Some optimistic assumptions
From ArXiv: 09091896

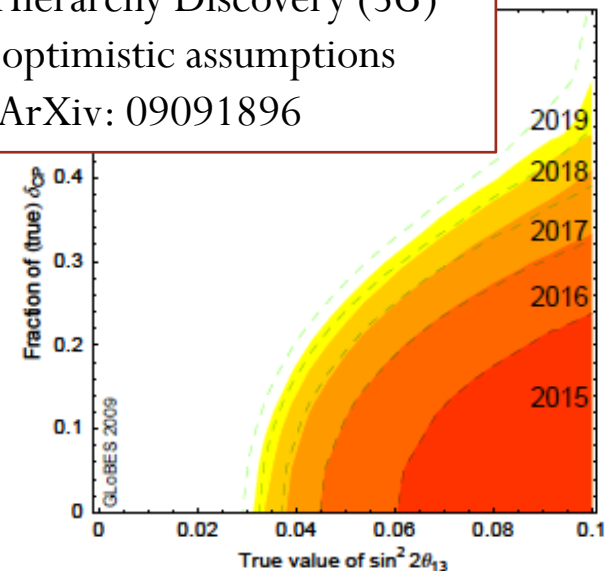

Future long baseline experiments

- The recent discovery of θ_{13} has crystallised the effort in the planning of the next generation of experiments.
- The following proposals are the culmination for a decade of work exploring new ideas and technologies.
- Next Generation experiments to:
 - Determine mass hierarchy, aim for 5σ precision.
 - Maximise sensitivity to CP violation.
 - Test the standard picture of 3 generation mixing.
 - Aim for a complementary broad physics program with astrophysical neutrino and proton decay measurements.

The European Option: LAGUNA-LBNO

- European design study to investigate future long baseline experiments and large underground facilities.
- LAGUNA 2008-2011
 - Detailed investigation and engineering of 7 sites across Europe
 - Detector technologies and capabilities.
 - > 1000 pages of documentation produced.
- LAGUNA-LBNO 2011 -
 - Continued investigation and planning of 3 sites for long baseline neutrino experiments.
 - Pyhäsalmi Glacier, LENA
 - Frejus : Mephys
 - Further exploitation of CNGS.

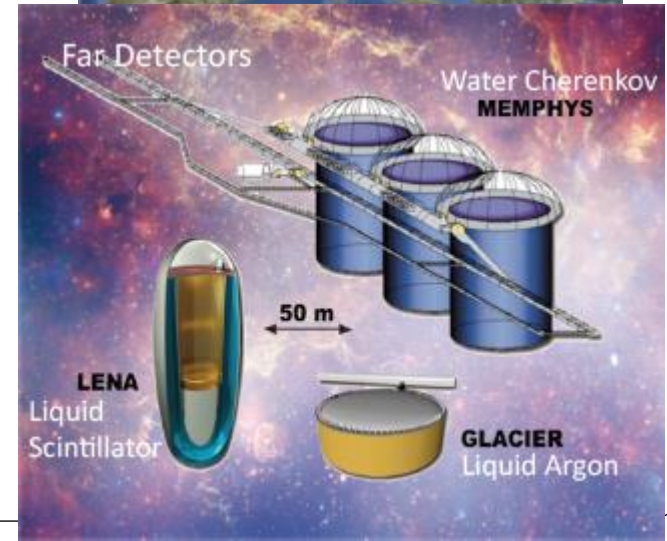

CERN-Pyhäsalmi

- Neutrino beam from SPS
 - 500kW
- Far site to host
 - 20kT double phase liquid argon TPC Glacier
 - 50kT magnetised iron calorimeter MIND.
- Resolve first and second oscillation maxima
 - Increases CP sensitivity
 - Test of oscillations
- Large distance
 - Spectacular matter effect!



The Beamline

- CERN already has the most powerful neutrino beam
 - CNGS 500kW
 - Natural starting point for design
- Relatively short tunnel (300m) but 10° dip angle.
 - Target station and tunnel in NA.
- Potential improvements with upgrades for HL-LHC
 - Studies on going at CERN.
- Number of upgrade paths
 - SPS upgrades – 700 kW
 - New accelerator HP-PS 2MW

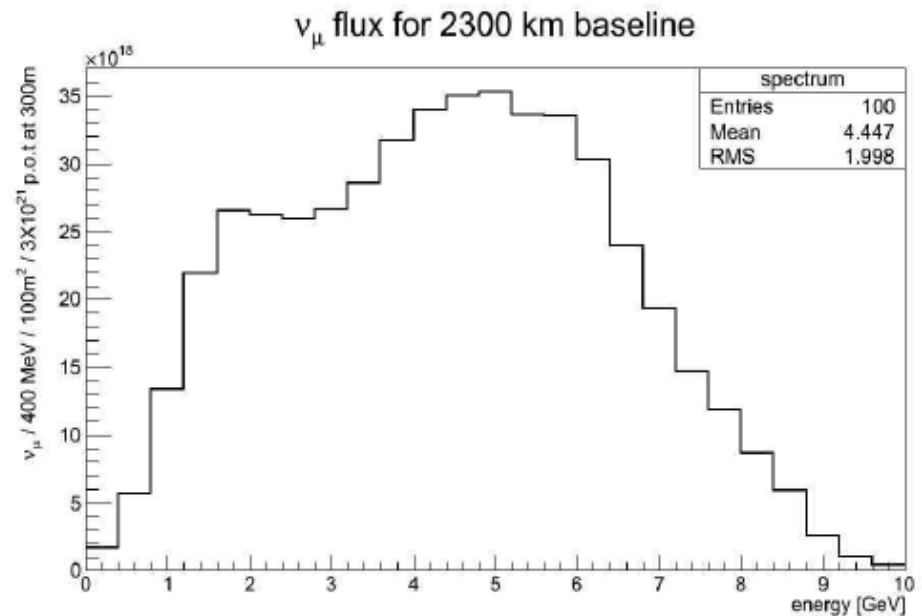

The mine at Pyhäsalmi

- Deepest mine in Europe
 - Depths to 1400 m possible
 - Produces Cu, Zn and FeS₂
- Currently a working mine
 - Reserves until 2018
 - Chance to take over this infrastructure
- Access underground via 11km tunnel and via shaft.
- Distance via road
 - Oulu – 165 km
 - Jyväskylä – 180 km
 - Helsinki 450 km
- Strong support from Finland
 - €1.6 m for site investigation
 - Further high level discussions on going



250 m long tunnel and a cavern at 1400 m excavated for LAGUNA R&D

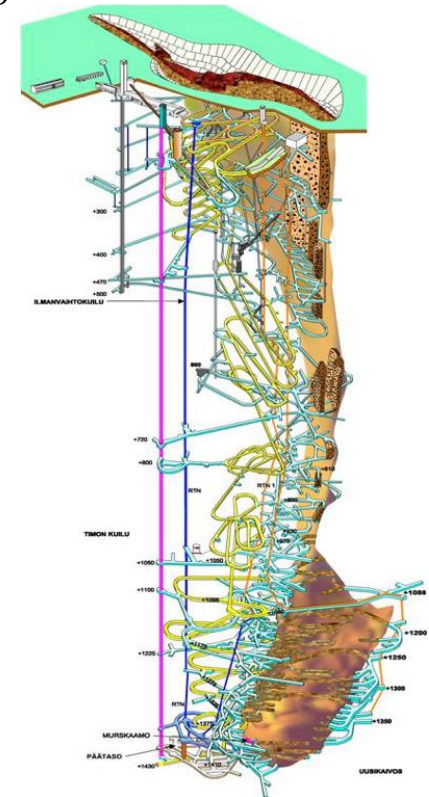

Possible Underground Layout

- Space for
 - 2x50 kton LAr TPC.
 - 50 kton magnetised iron calorimeter
 - 50 kton liquid scintillator detector
- Proposed site in mine at 1400m depth
- Area now under detailed investigation.

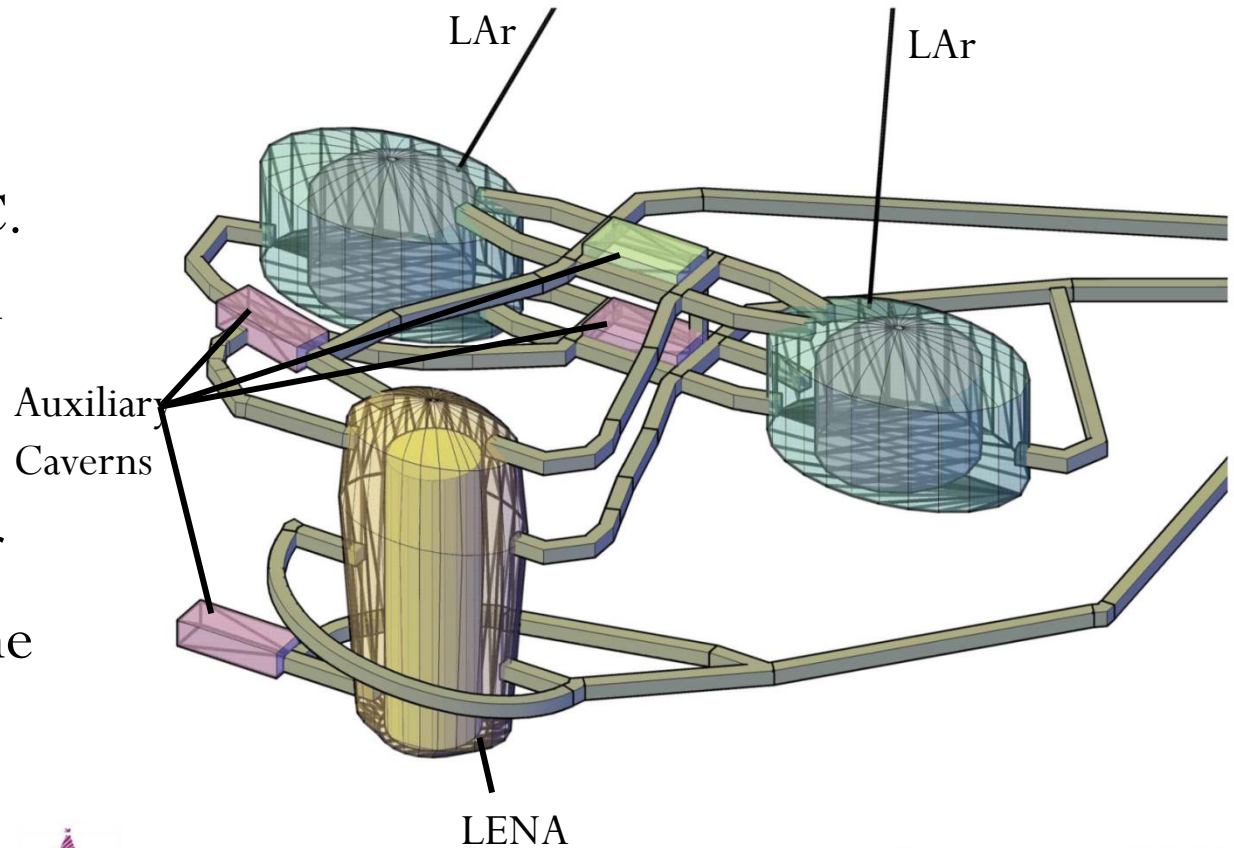

AXONOMETRIC VIEW, LAr AND LSc SOUTH - WEST

2.7.2012

COPYRIGHT ©  ROCKPLAN

Far Detector Options

- To fully exploit the beamline the far detector must have the following capabilities:
 - Must be scalable to the large masses required.
 - Must be able to distinguish electrons and muons
 - Must be able to reconstruct many tracks at once
 - Should have excellent energy resolution.
- To achieve this we study as many possible technologies as possible
 - Combinations of detectors to give best results?
- Note water Cherenkov does not meet these criteria.

Glacier

- 20 kton double phase LAr LEM TPC.
 - Very fine grained tracking calorimeter
- Best detector for
 - Electron appearance
 - Reconstruction of multiple tracks from high multiplicity events.
- Excellent ν energy reconstruction.
- Low energy threshold for all particles

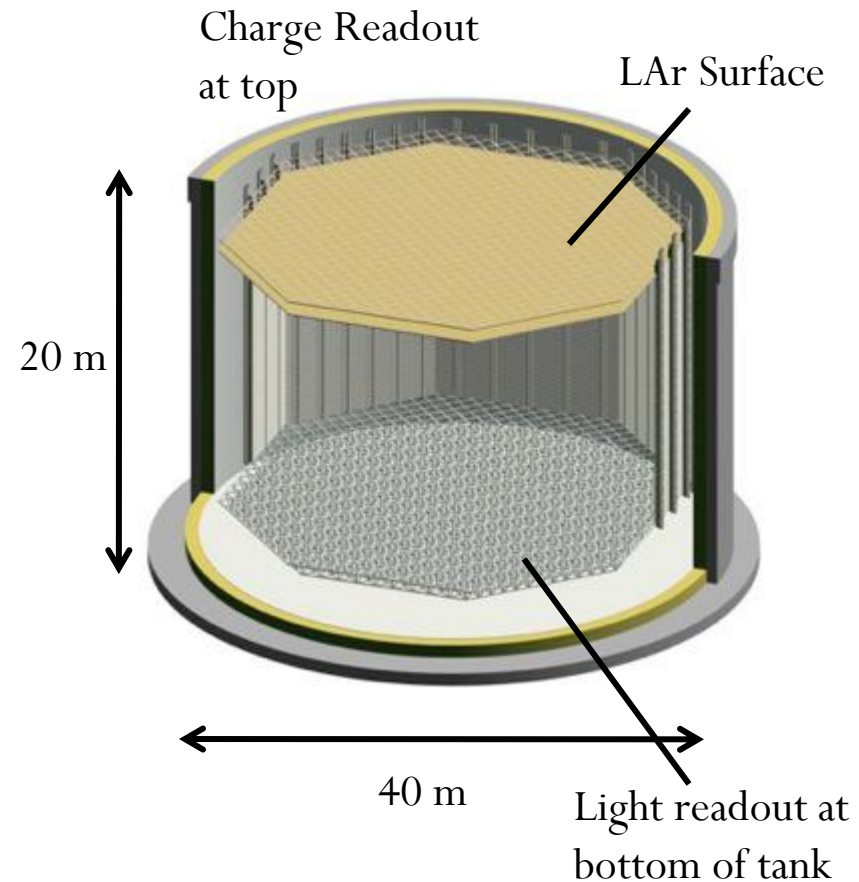

Events in LAr

View 0: Event display (run 14456, event 8044)

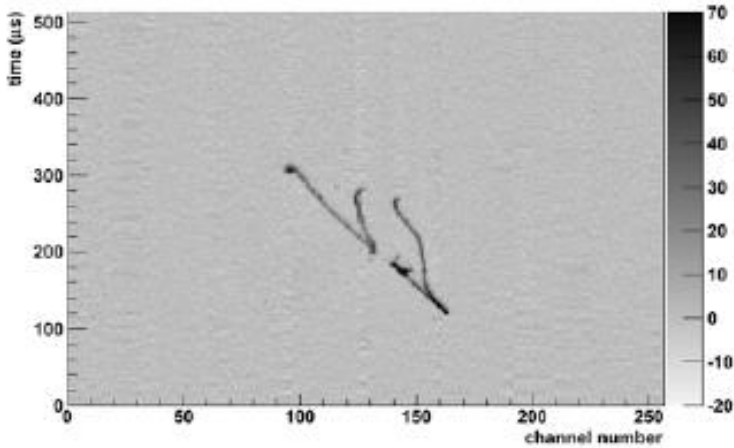

View 1: Event display (run 14456, event 8044)

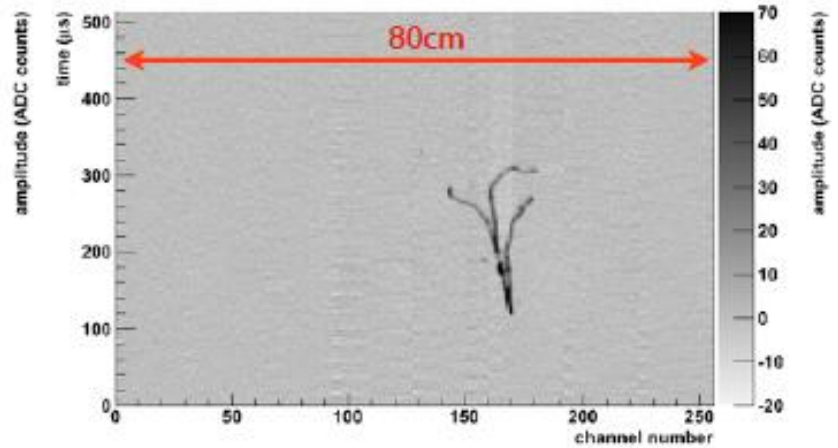

View 0: Event display (run 14450, event 1511)

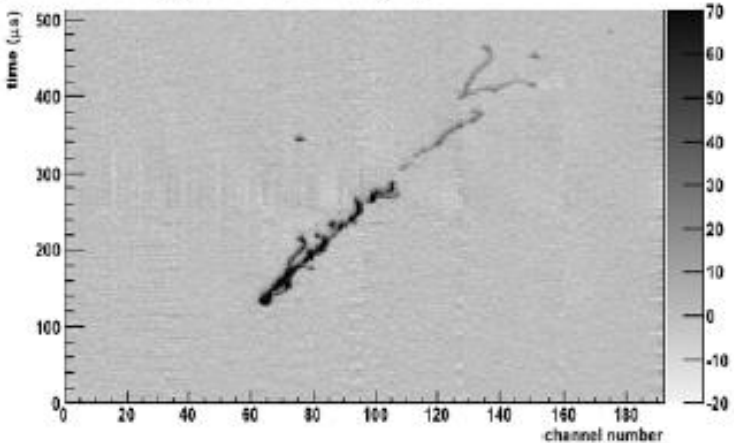

View 1: Event display (run 14450, event 1511)

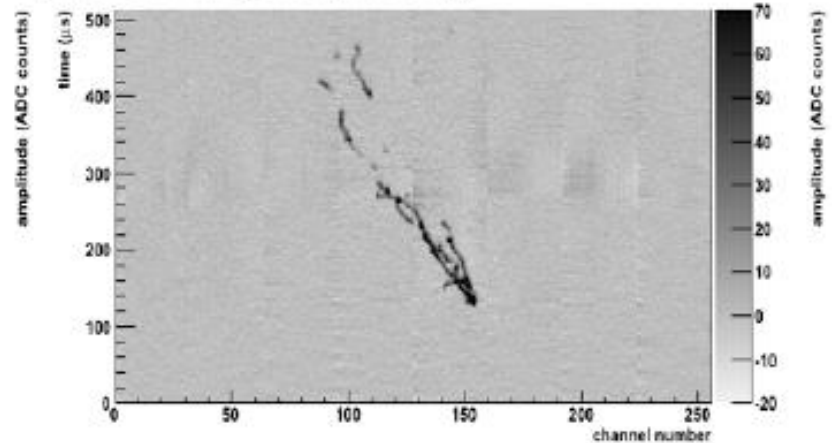

Reconstruction in Liquid Argon

- Studies underway to simulate LAr TPC and to reconstruct the events.
- QSCAN software provides testbed for simulation and reconstruction tools.

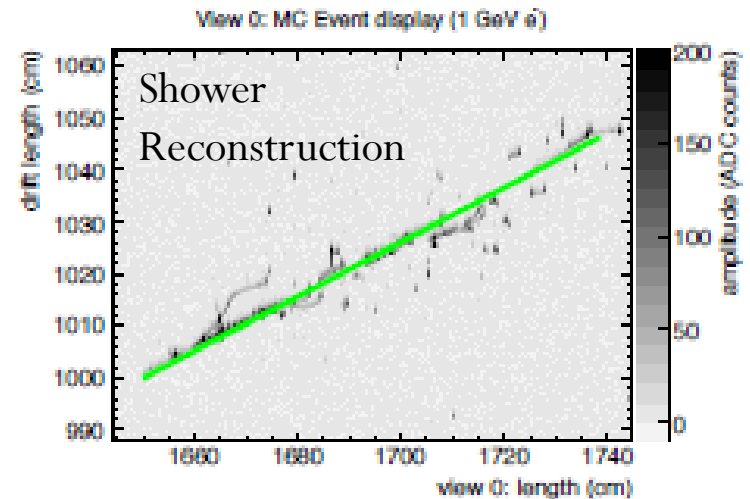
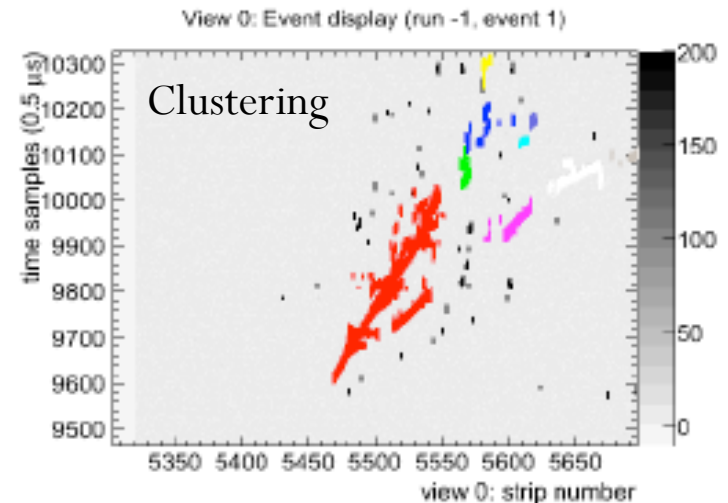

MIND

- Magnetised Iron Calorimeter
 - Similar to MINOS
 - Well proven technology
- 3cm Fe Plates, 1cm Scintillator Bars
- $B = 1.5\text{-}2.5\text{ T}$
- Measurement of muon momentum distribution and total neutrino energy.
- Excellent Charge determination
 - Ideal far detector for future neutrino factory.

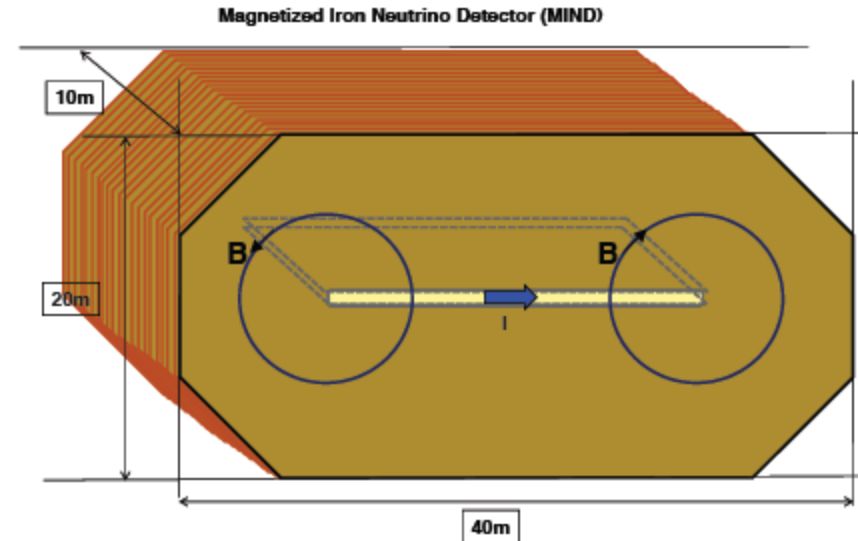
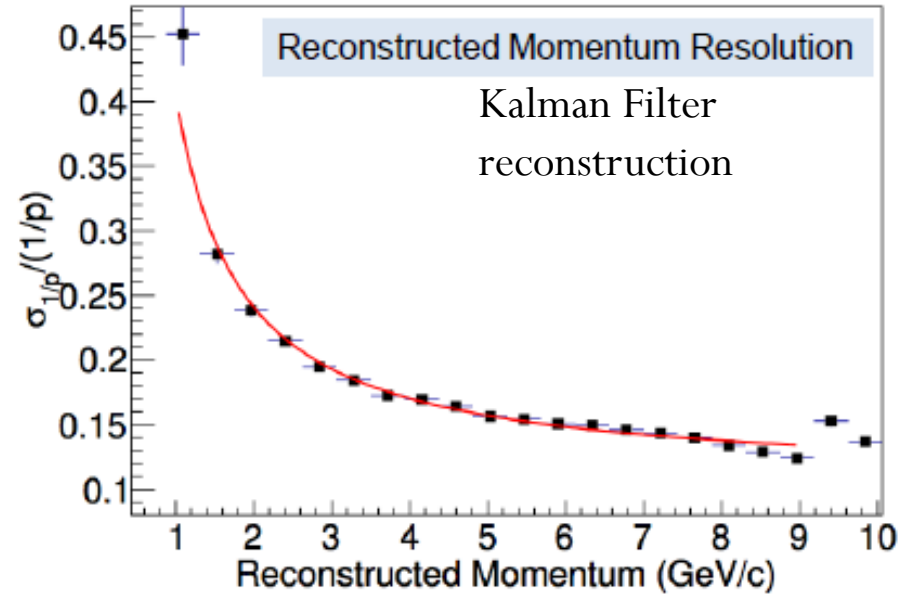

LENA

- Liquid Scintillator detector
 - Proven technology, scaled up.
- As well as beam measurements rich physics program
 - Solar neutrinos
 - Supernova neutrinos
 - Atmospheric neutrinos
 - Proton Decay
- Target : 100m high x 26m diameter
 - 50 kton
- 45000 8" PMTs



Signals at Pyhäsalmi : Normal Hierarchy

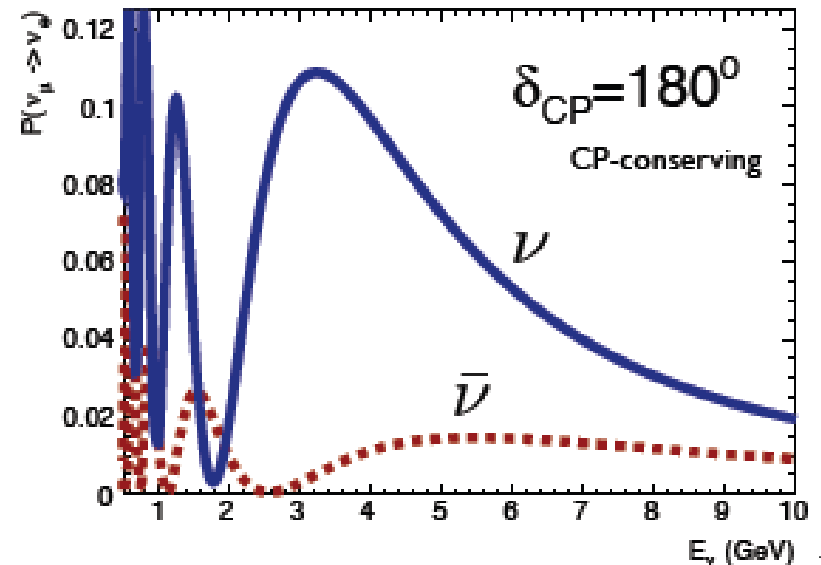
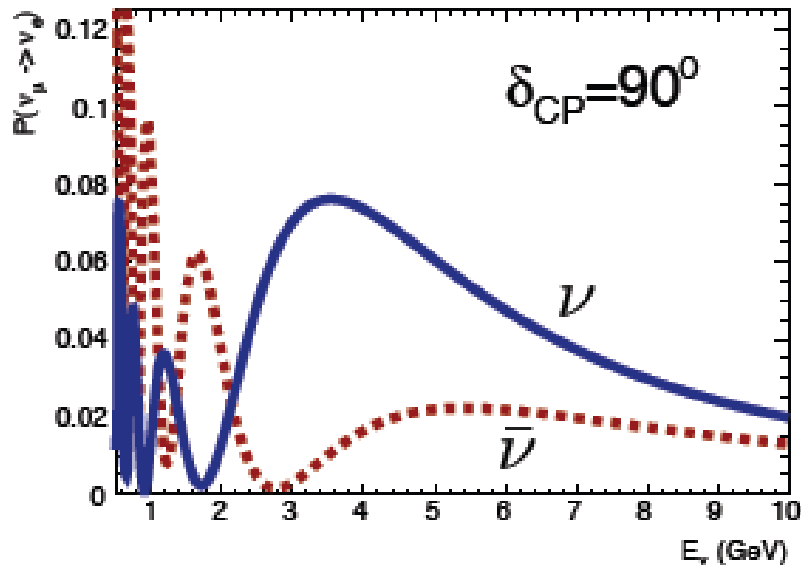
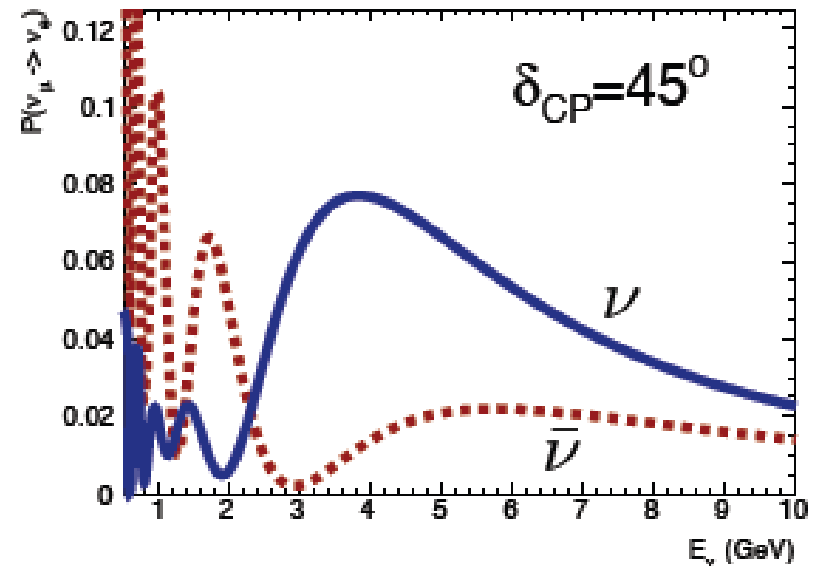
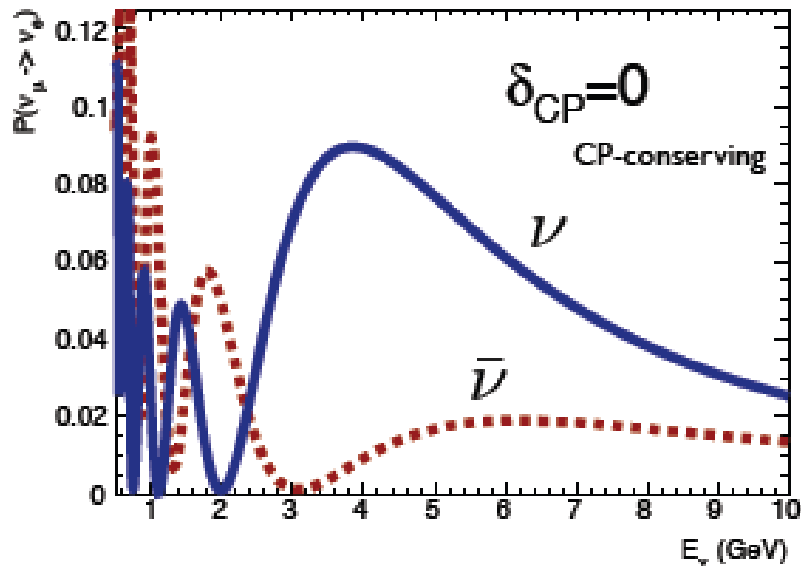

Signals at Pyhäsalmi : Inverted Hierarchy

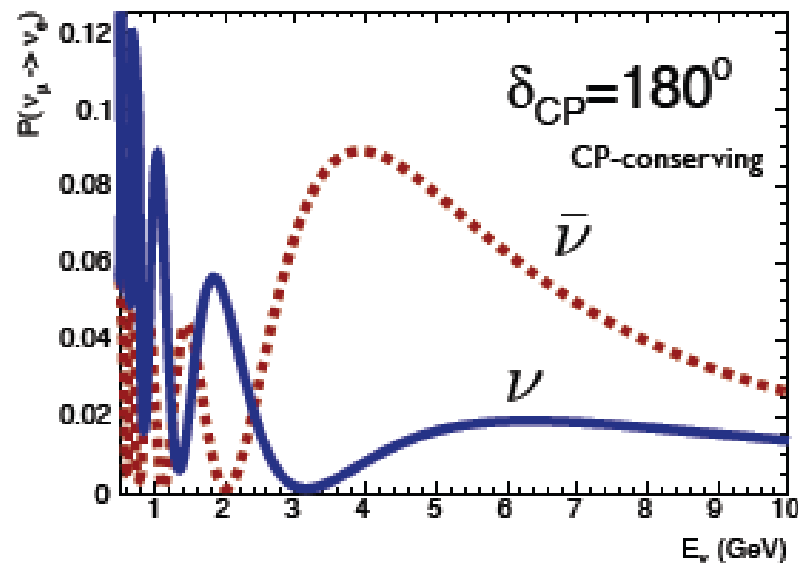
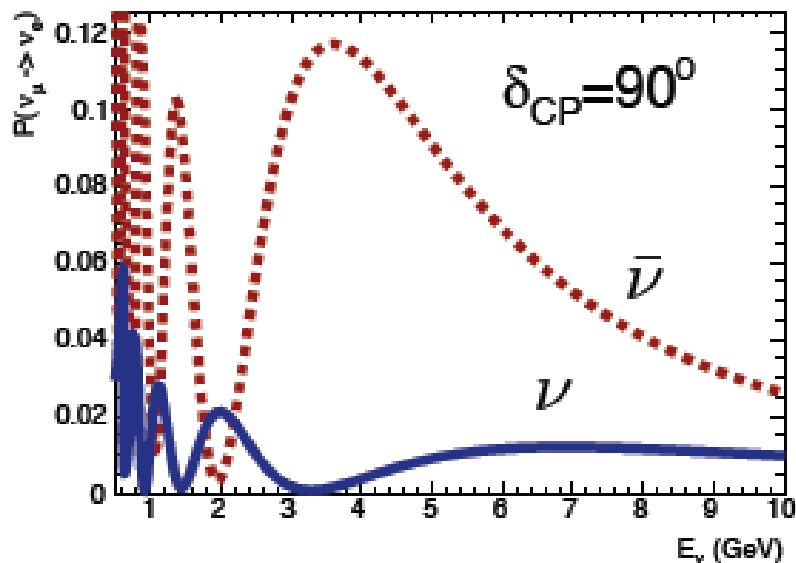
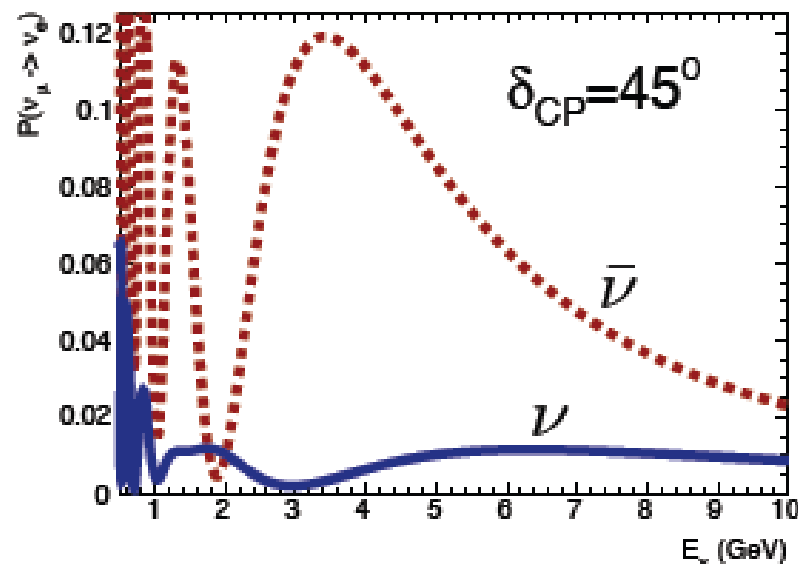
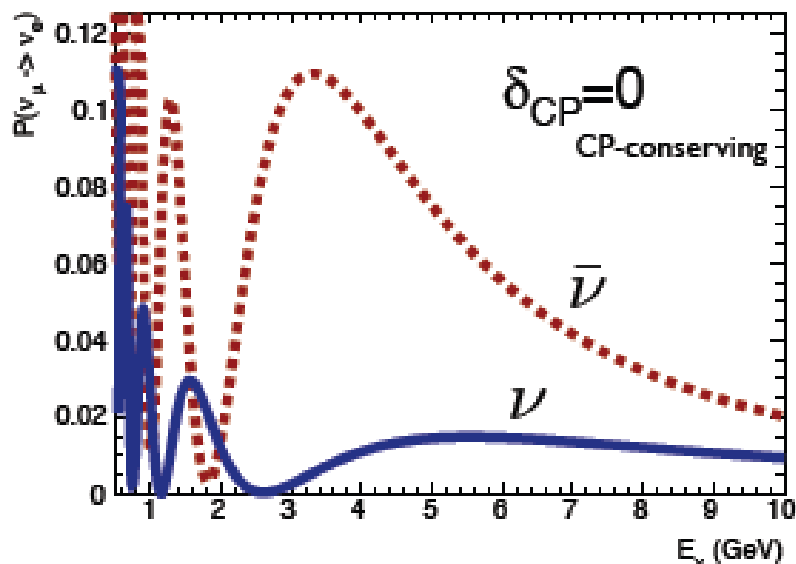

Flux Matching

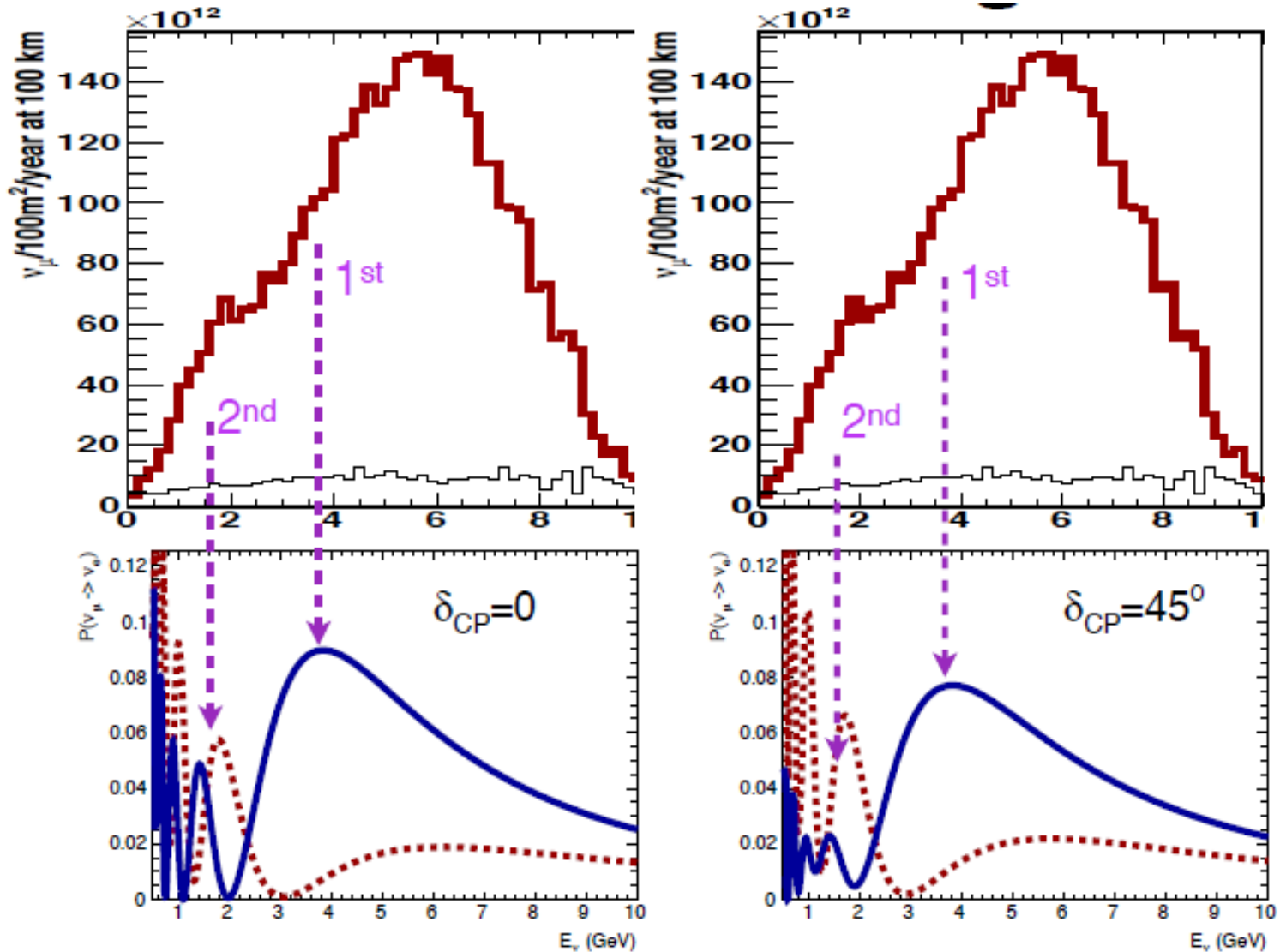

Expected ν_μ sample

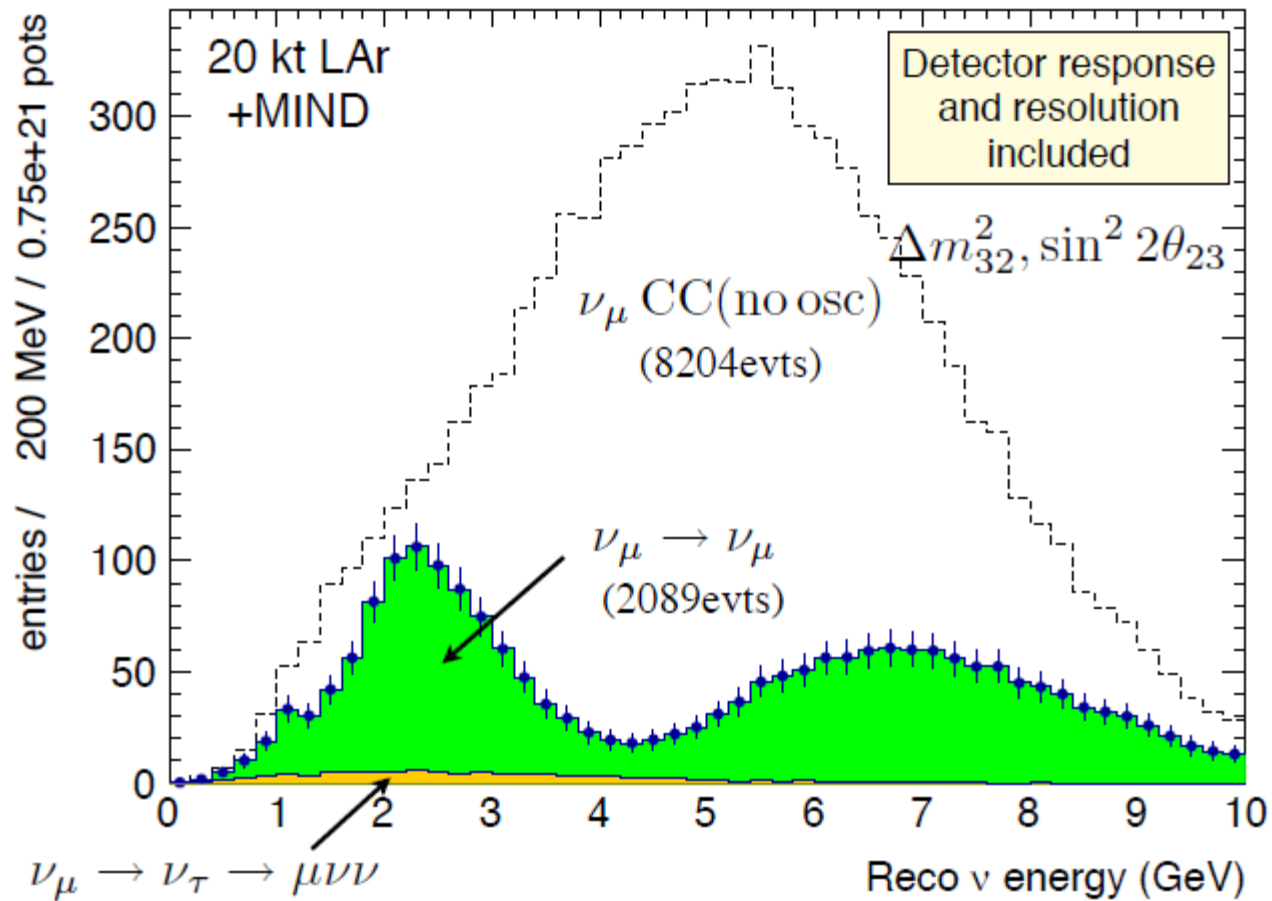

Expected ν_e sample

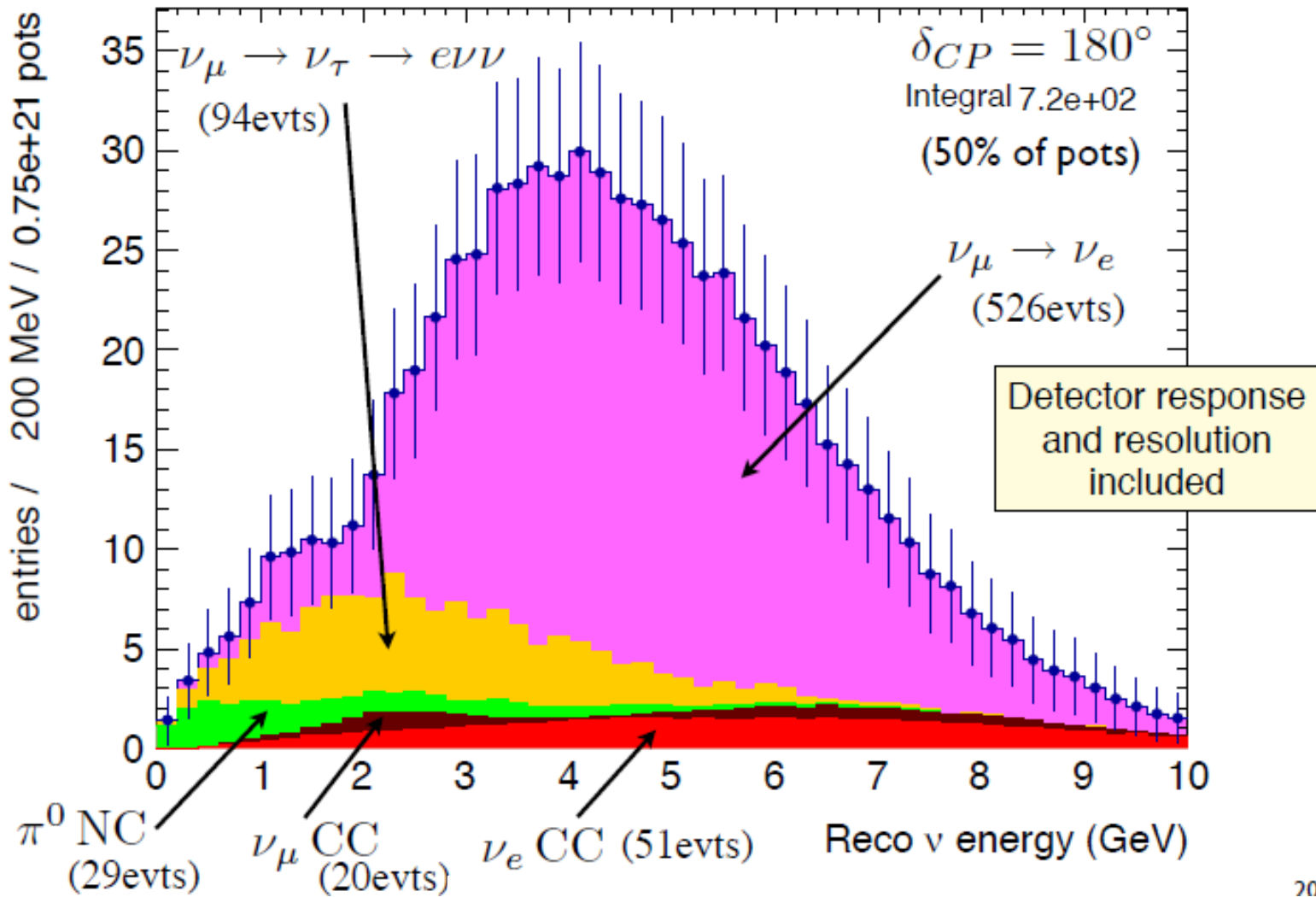

Determining oscillation parameters

Detector response and resolution included

Running mode:
 $\nu/\text{anti-}\nu$:25%/75%

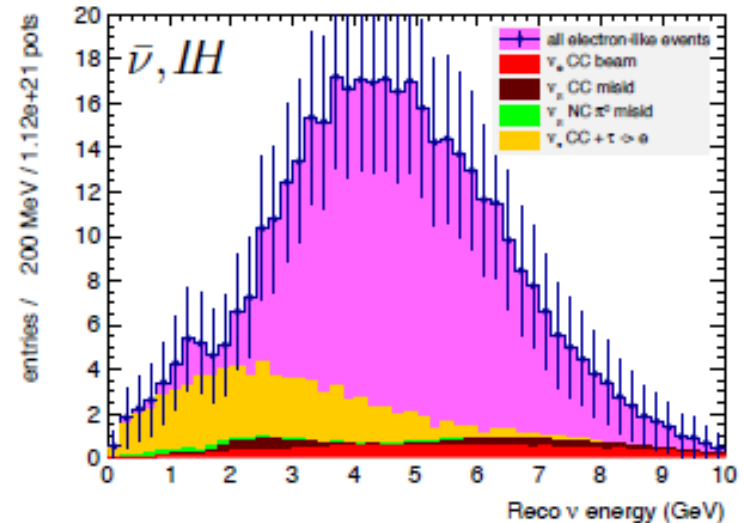
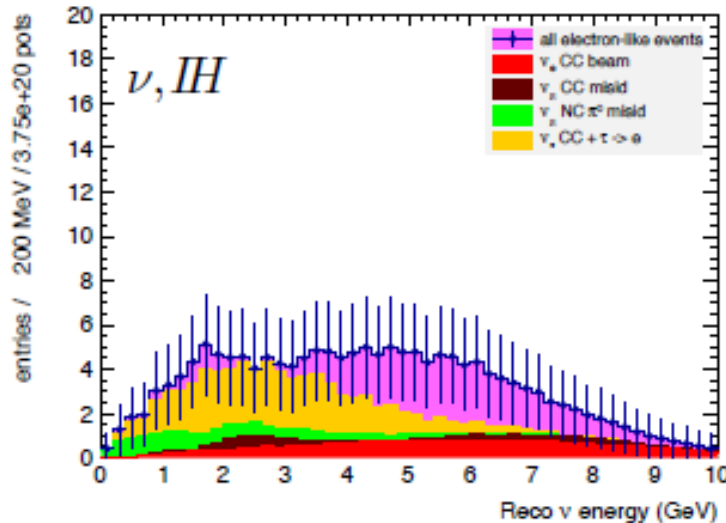
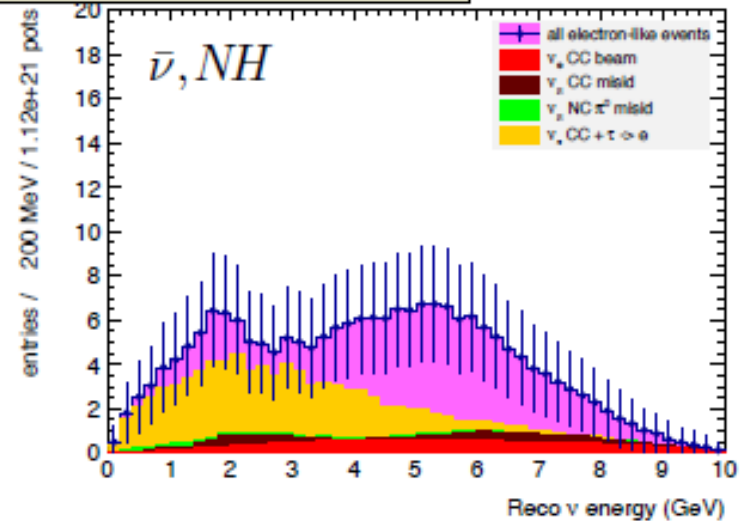
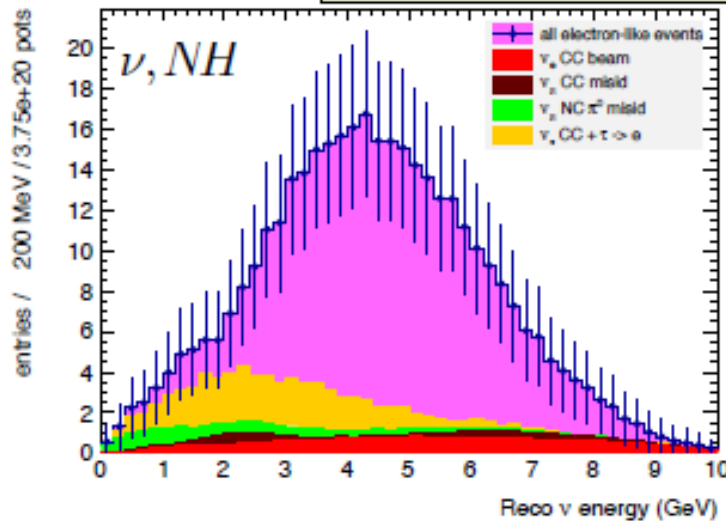

Physics reach of CERN- Pyhäsalmi

- After 10 years:
 - Full coverage of matter effect at 5σ .
 - 71% (44%) coverage of CPV at 90% (3σ).

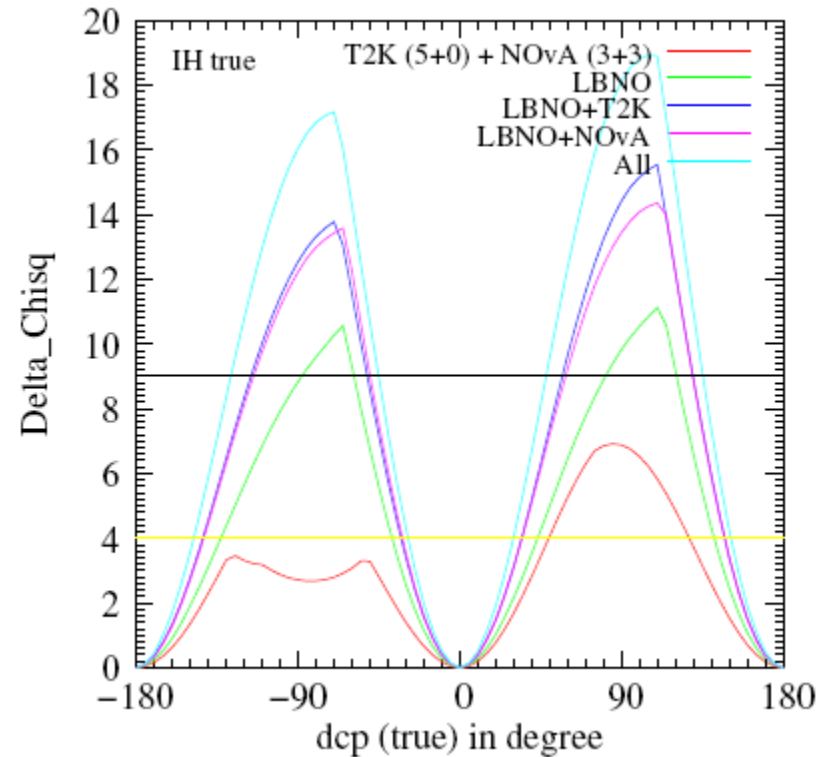
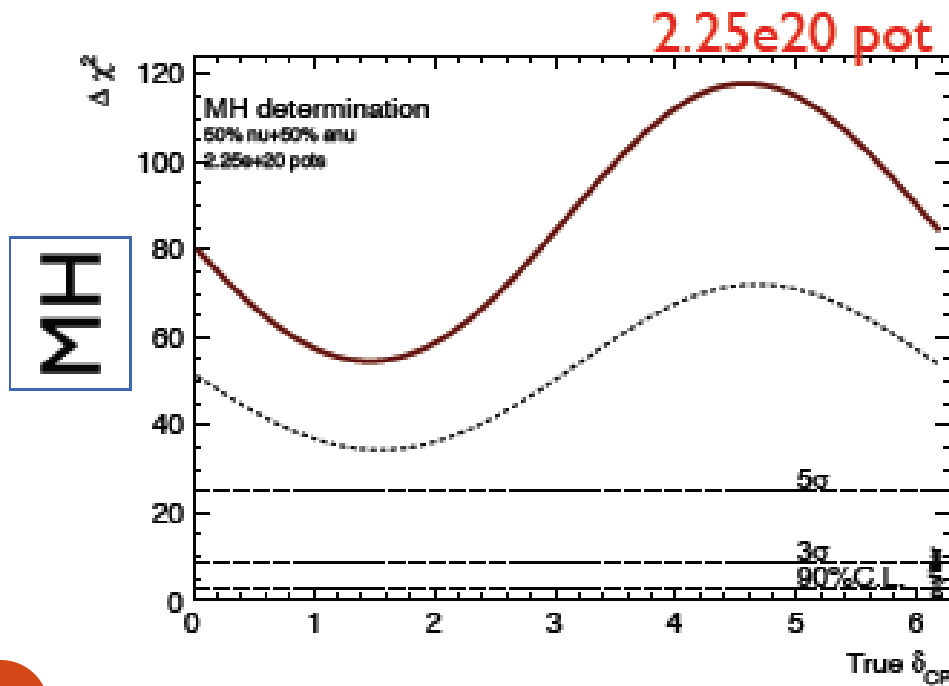

CP Coverage

Incremental approach with conventional beams

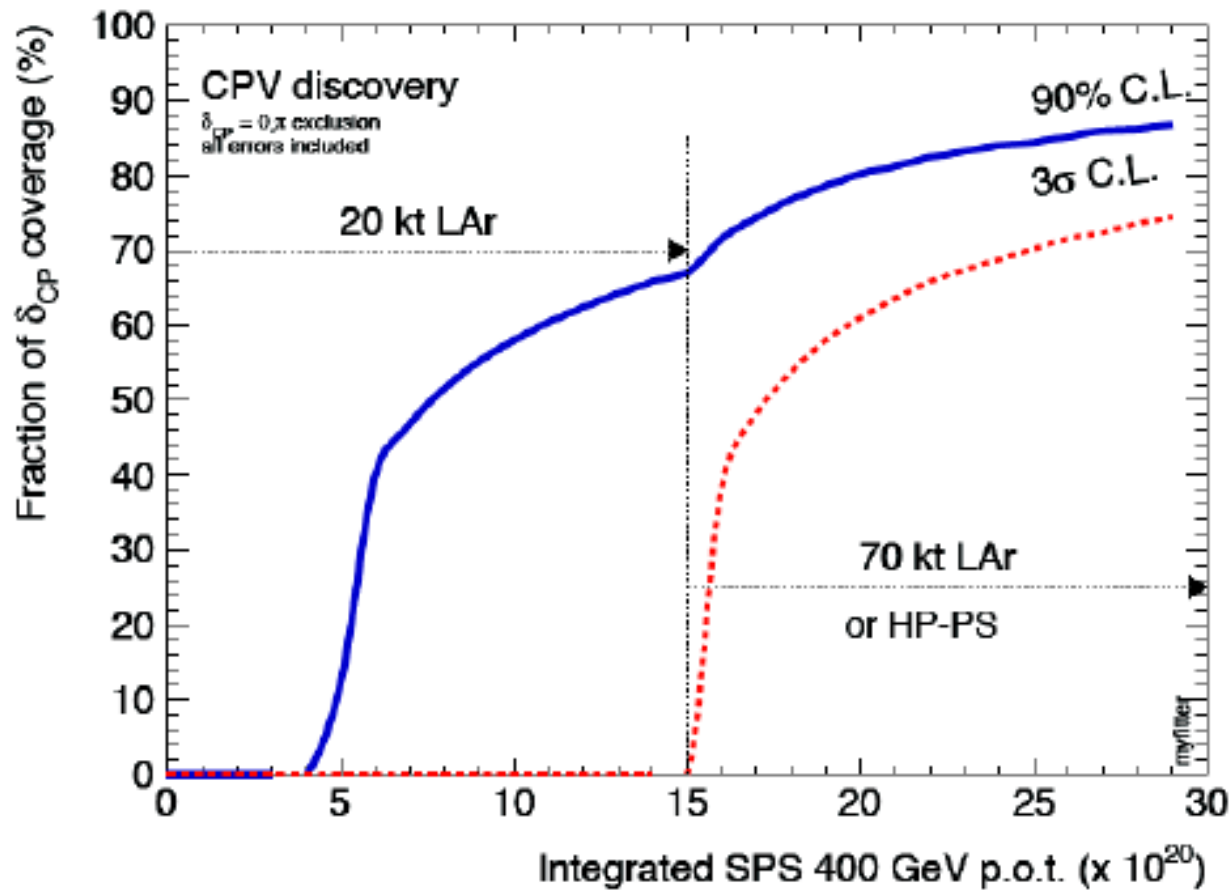

Near Detector Options

- A near detector will be required to control beam systematics and measure required cross sections.
- Can place the detector between 300m and 800m from target.
- Challenges:
 - Fully reconstruct DIS events
 - Match target materials
 - Detector Speed
- There is now a dedicated working group looking at the near detector design.

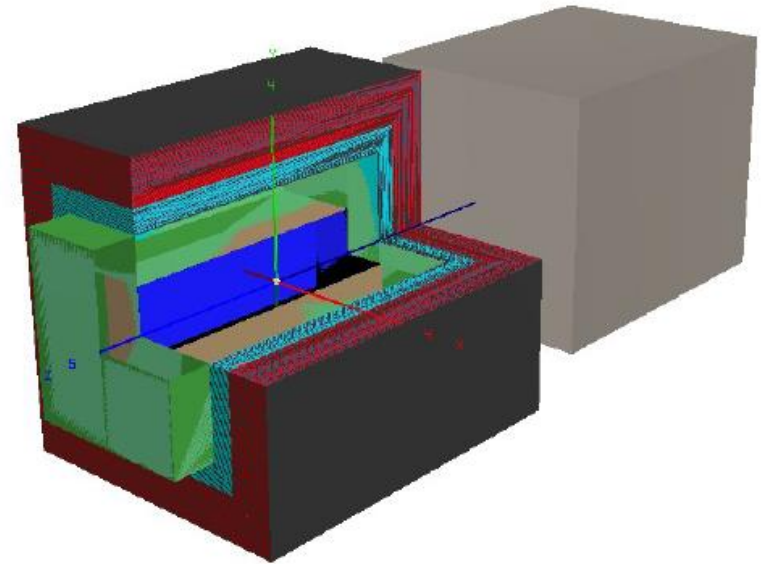

Possible Option:
High Pressure Ar TPC surrounded by
scintillator with magnetic field
Followed by a magnetised iron calorimeter

The LAr testbeam program at CERN

- CERN is now planning and will start construction on a testbeam facility for liquid Argon detectors
 - Extension of existing beams in the north area
 - LAr infrastructure and detector pit provided
- Will provide
 - Charged particles from the test beam facility
 - Neutrinos from the potential short baseline program.
- Laguna liquid argon prototype will exploit this facility
 - 6x6x6 m detector
 - 300 tons of liquid Argon.
 - 5m drift
 - Ability to swap out readout
 - Full test of technology for Glacier.

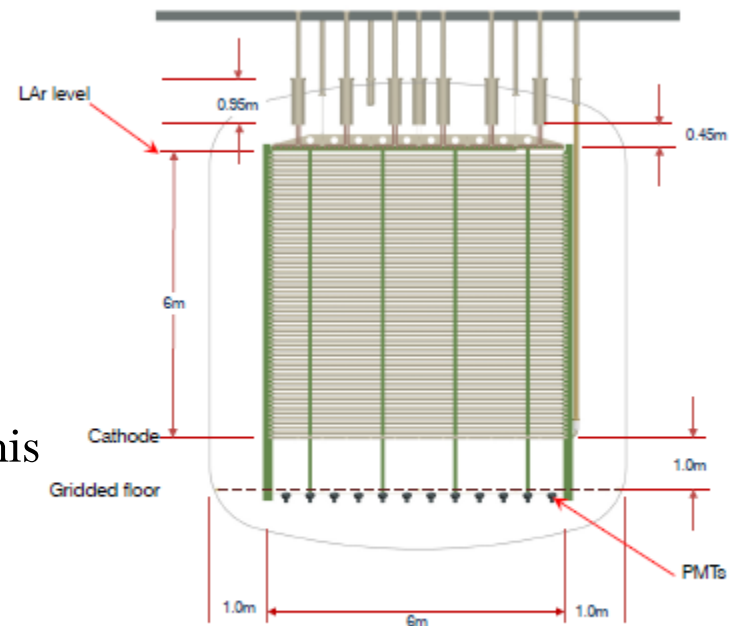

Timeline for LBNO

- LAGUNA design study 2008-2011
- Start of LAGUNA – LBNO 2011
- Submission of EOI to CERN SPSC summer 2012
- Extended site investigations 2013
- End of LAGUNA LBNO 2014
- LAGUNA LAr prototype at CERN begins 2014-2016
- Critical decision 2015?
- Construction from 2016?
- Start of physics running 2023?

US Program : LBNE

- Neutrino Beam from Fermilab to homestake
 - Baseline of 1300 km
 - Good sensitivity to matter effect and CP.
- Recently underwent reconfiguration to meet US budgetary constraints.
 - Requirements for a staged approach
- Phase 1
 - Construct upgradeable beamline FNAL-Homestake 700 kW.
 - 10 kt surface single phase LAr TPC.
 - No near detector.
- Obtained CD1 at end of 2012

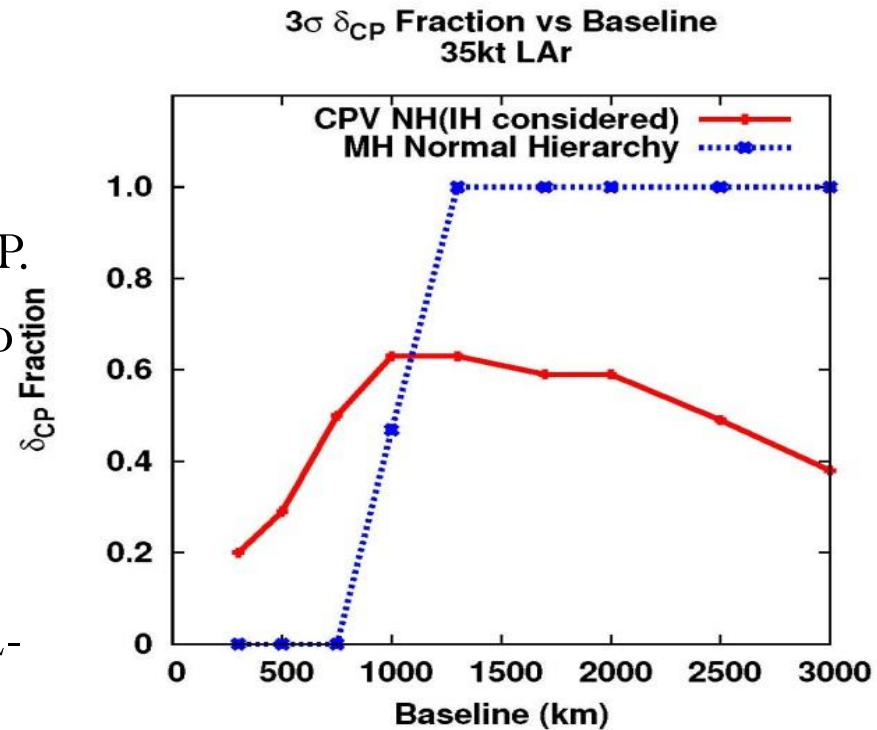

Physics Reach of LBNE phase 1

- Can determine mass hierarchy at 3σ .
- Some coverage of CP violation.
- Precision measurement of other oscillation parameters.

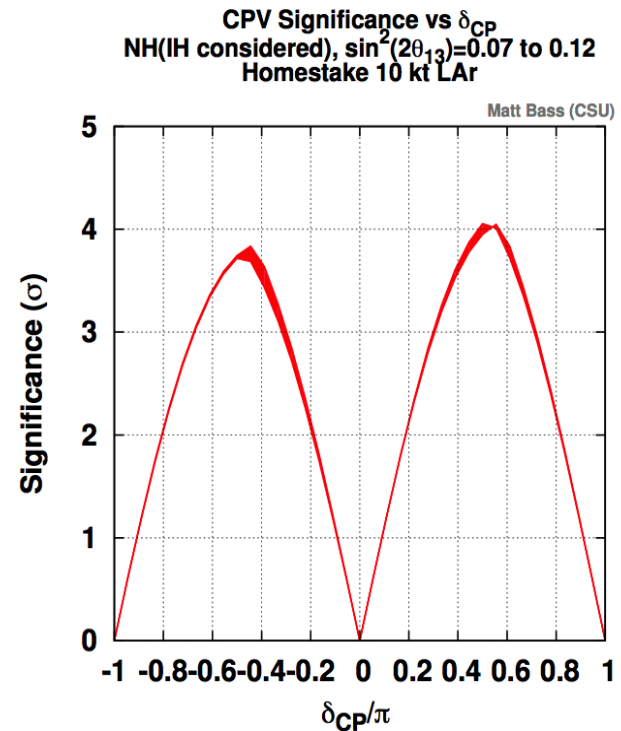
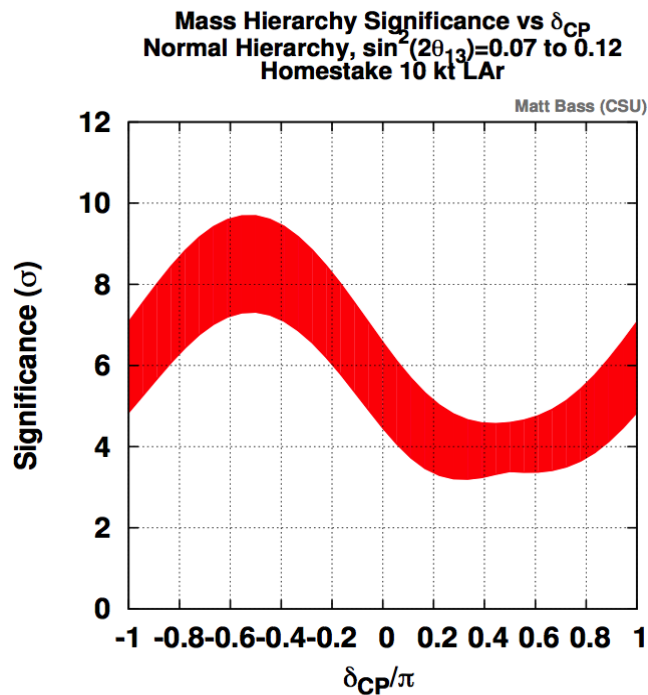

Upgrades to LBNE

- Scope for future development
 - Far Detector underground : 35kt LAr
 - Intensity : Project X
 - Improved systematics : Near Detector(s)
- There is also scope for foreign investment in phase 1.
 - 15% additional cost - far detector underground.
 - 15% additional cost - add near detector.
 - Open to contributions to any aspect of the project.
- The US is now actively looking for partners in LBNE to increase the scope of the phase 1 program.

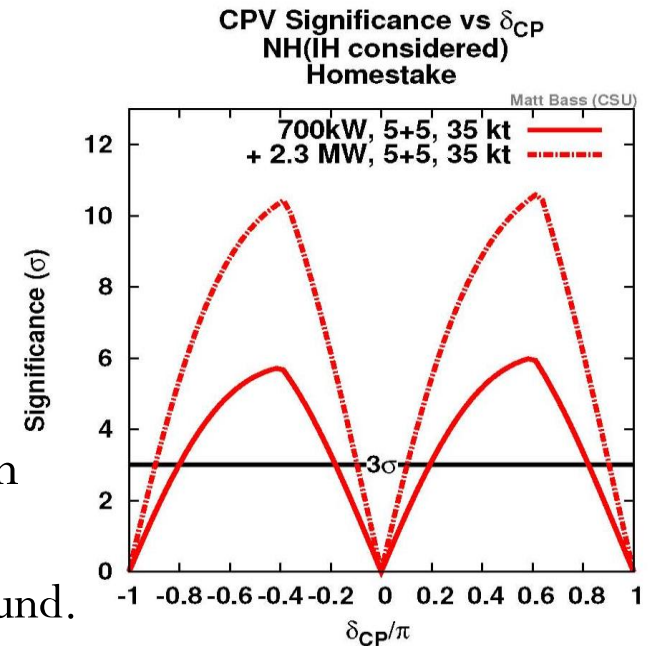

Final LBNE Configuration.
60% CP violation coverage at 3σ .

Liquid Argon R&D in the US

- Unlike European option the US are investigating single phase technology
 - Ala ICARUS
- ArgoNeut
 - 500l detector in NuMI beamline
 - Taking data
- MicroBoone
 - 150 ton detector in MiniBoone Beamline
 - Under Construction

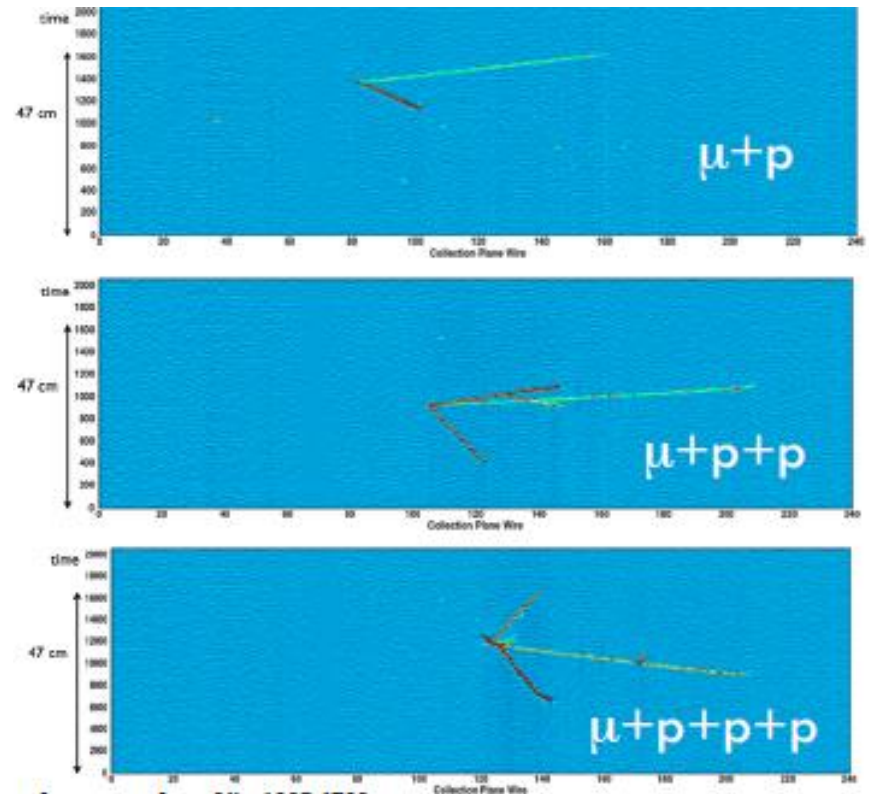

ArgoNeut data

The Japanese option

- Exploit the current JPARC neutrino beam.
 - Expect 750kW by ~2020.
- Hyper-Kamiokande
 - 0.56 Mton fiducial water Cherenkov
 - ~20 x SK
 - 2 caverns
 - 99000 PMTs
 - 20% coverage
 - Aim for construction in 2018
- Collaboration starting to form

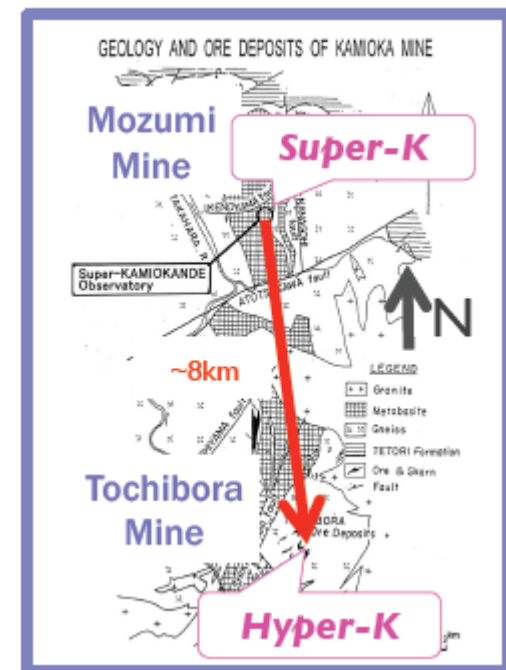
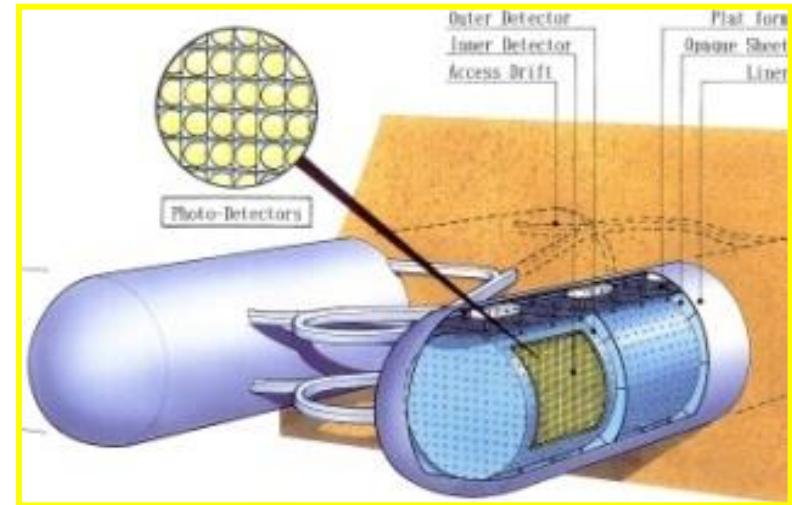

Effect of δ

1 year = 10^7 sec

Difference from $\delta=0$ ν_e candidates

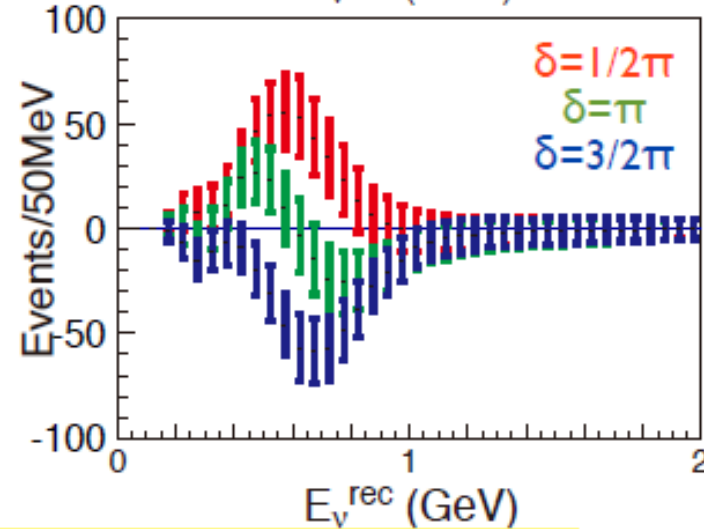
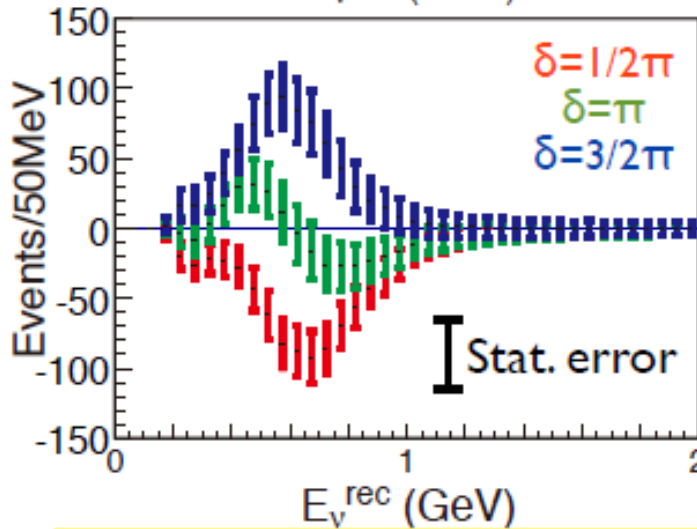
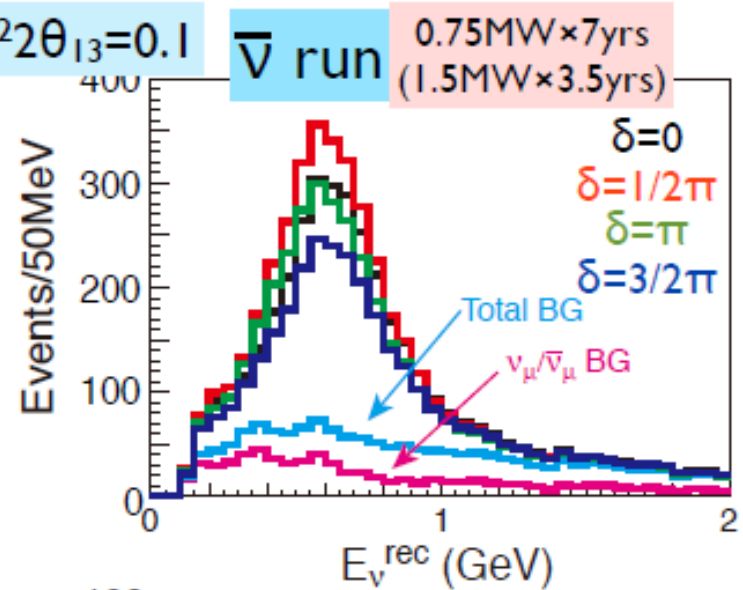
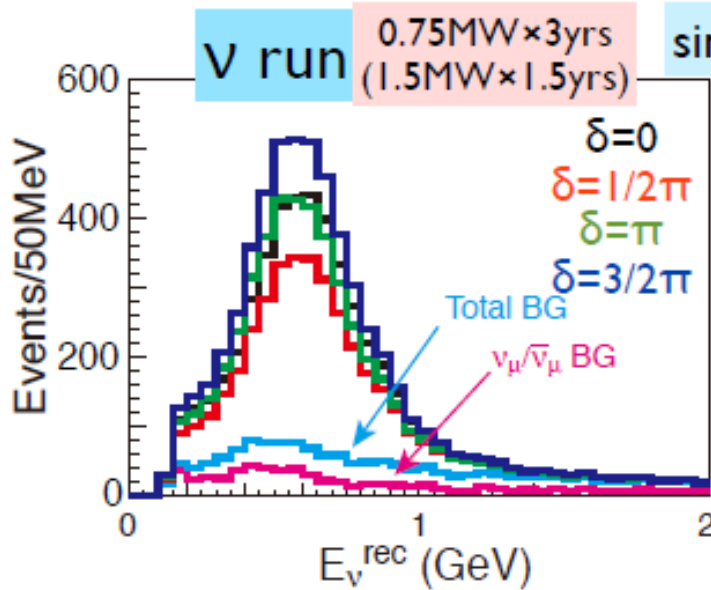

Number + shape: sensitive to all values of δ

Hyper Kamiokande Sensitivity

- Assume 3 year neutrino / 7 years anti neutrino.
 - 5% systematics
- Good sensitivity to CP
 - 77% (55%) coverage at 3 (5) sigma.
 - Aim to access to Mass Hierarchy though joint analysis with atmospheric neutrinos and other experiments.
- Rich physics program of proton decay, extraterrestrial and atmospheric neutrinos.

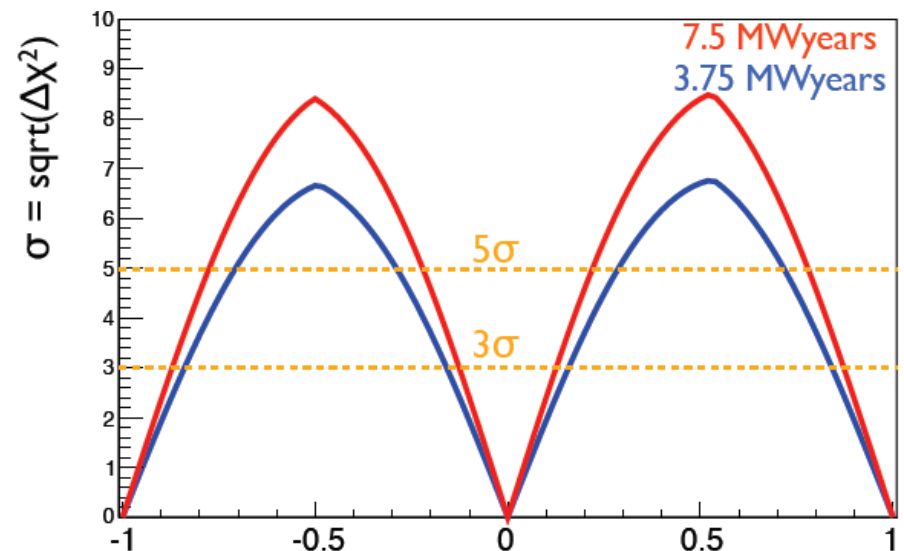
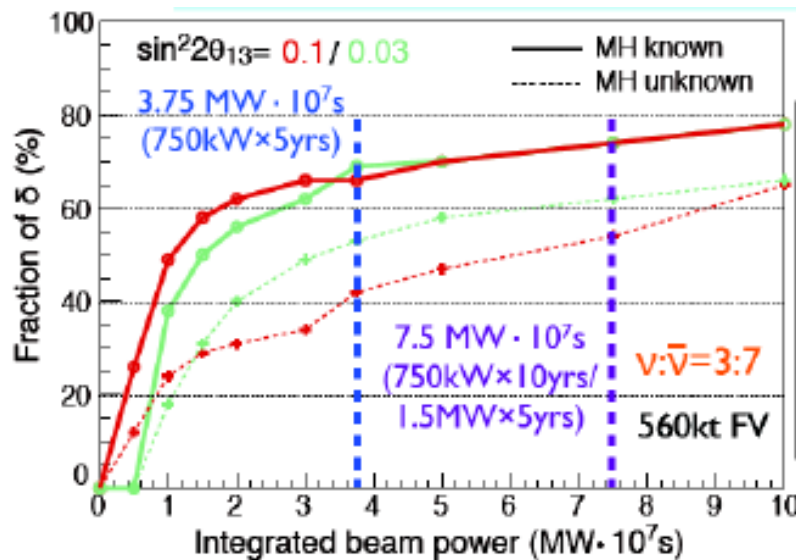

Other physics at Hyper-K

- Proton Decay
 - Increased sensitivity for
 - $e\pi > 1.3 \times 10^{35}$ years
 - $K\nu > 3 \times 10^{34}$ years
 - Many other modes possible
- Atmospheric Neutrinos
 - Major statistics increase
 - Can aim for mass hierarchy
- Supernova Neutrinos
 - Sensitive to any galactic supernova with huge statistics
 - Discovery of relic supernova neutrinos
 - ~ 0.5 events for a typical supernova in the local cluster
- Solar Neutrinos
 - Very high statistics for day-night asymmetry.

Comments on the long baseline program

- The discovery of large θ_{13} has condensed the options for the next generation of long baseline experiments.
- 5σ measurement of the mass hierarchy and significant regions of the CP violating phase are possible.
- Mixing measurements should be made at high precision to test the 3 neutrino mixing paradigm.
- Experiments and facilities should be designed for further extension to future experiments, should the data guide us in that direction.
- Experiments to measure neutrino cross sections and hadron production will also be required and will play a key role in these measurements.

Conclusions

- Discovery of θ_{13} signposts the next steps for long baseline neutrino experiments.
- There is an experimental program that will take us to ~ 2020
 - Longbase line experiments
 - Test beam program
- To allow for clear and unambiguous discoveries we need to next generation experiments
 - Need to push forward with these steps.